

STÅENDE™
COLLECTION

2019 PRICE LIST

Terms and Conditions of Sale

Credit and Payment Terms

Nevers Industries Inc policy does not allow for automatic open account terms for new customers, customers whose account is not current, individuals or residential accounts. New customers are required to make a deposit for the full value of the merchandise ordered. A credit application will be sent to each new customer. Credit will be established upon review of the responses given by the customer's references and will appear on future order acknowledgements. **New customers are encouraged to begin establishing a credit rating with Nevers Industries prior to placing an order.** Our customers are responsible to provide the necessary current and accurate information. Upon establishment of an open account, the first order is 100% net due upon receipt. Future orders will be 50/50 net 30. 1-1/2% per month service charge will be added to all past due accounts. Accounts that are 90 days past due will be subject to collection proceedings without any additional notice. Orders will not be processed for past due accounts until the amount due, including any service charges, is paid in full. Custom orders will require a down payment of 50% and will not be scheduled for production until the down payment is received. **A bank letter of credit may be required for any order over \$50,000 net.**

Prices

Our prices are list; freight prepaid, F.O.B. Maple Grove, Minnesota, and are subject to change without notice. Quoted prices must be accepted within 30 days or re-quoted for date and approval. Freight is prepaid and allowed for normal ground transportation within the 48 contiguous states, must ship to dock location. Air freight, will calls, and special delivery will be quoted and invoiced separately. Prices do not include installation, storage, or sales tax.

Packaging

Nevers Industries Inc pricing includes packing for North American shipment. Only environmentally safe packing materials are used. Large furniture pieces will be packed with wood reinforcements for added protection. For special packaging, crating or overseas shipment, please contact our Customer Service Department.

Delivery

Nevers Industries Inc will select the method of shipment, carrier and routing. Carrier selection is solicited to provide the best service to each customer in their particular location. All shipments are sent prepaid, FOB Maple Grove, Minnesota. Nevers Industries Inc liability ends when the carrier issues a receipt to Nevers Industries Inc. This is acknowledgement by the transportation company that the shipment has been received by the freight company in good condition and title of the goods and risk of loss transfers to the buyer. The order shall be considered complete. Prepaid freight does not change the F.O.B. status of the product and risks involved in invoices relevant to the partial shipments are payable as they fall due.

Freight Terms

All orders under \$2,000 net are subject to a minimum order/additional freight charge of \$275 net; Nevers Industries Inc also reserves the right to establish a freight and fuel surcharge fee to cover variable freight costs. This charge will be established at the time of order and acknowledgement date.

Lead Times

The lead time on an order begins when Nevers' Order Entry Department has verified the validity of the items ordered and has received at our manufacturing facility all COM materials supplied by others. All acknowledgments will contain current lead time information. If for some reason the buyer does not want it early, please list a Do Not Ship before date. We are not responsible for delays in scheduling or failure to make scheduled shipping date due to strikes, lockouts or other labor complications, war, riots, Acts of God, fires, accidents, restraints affecting shipment or credit, reduced supply or excessive cost of fuel or raw material,

delays from suppliers, compliance with Government regulations, or other unforeseen contingencies. When delays in product delivery are caused by the purchaser, we reserve the right to draw up to 100% of the contract price and to charge to the purchaser any costs incurred by us due to such.

Order Acknowledgement

All orders are subject to final acceptance by Nevers Industries, Inc. Receipt of our acknowledgement indicates acceptance of your order subject to our terms and conditions. If pricing on the purchase order is different than the acknowledged pricing, the acknowledgement will take precedent over the purchase order. Nevers Industries, Inc. attempts to clarify all orders. But in the event of any discrepancy, please notify Nevers Industries Inc immediately. Failure to notify Nevers of a discrepancy within five (5) days will constitute acceptance of the order as acknowledged. All orders are subject to credit approval at any time.

Change Orders

Nevers Industries, Inc. will make every attempt to honor any reasonable change request to standard product provided that the request is received prior to start of production. Change orders will be accepted only if the request is made in writing and received in time to make the change. Nevers Industries, Inc. reserves the right to increase our acknowledged price and ship date if necessary to make the requested changes. Nevers Industries Inc will make every reasonable effort to stop production, scheduling shipments, etc., upon receipt of written notification of changes, cancellations, or deferments of delivery. Nevers will assess charges to the customer for change orders, cancellations, and delivery deferments as stipulated in the following:

Change Order Charges

Received prior to start of production will be charged \$500 net.

Received after engineering has started involving design changes or reductions in quantity will not be accepted. The customer will receive the goods as ordered and be liable for the amount due.

Cancellations:

Cancellations after receipt of the purchase order will be assessed the total accumulated cost of the project plus a \$500 net cancellation charge

Deferred Shipments

All merchandise will ship upon completion of production. If customer is unable to take delivery of merchandise when ready for shipment, Nevers Industries, Inc. may transfer the merchandise to storage. All cost for storage and freight will be at customer's expense. Transfer to storage will be considered delivery for all purposes including invoicing and payment. Customer will bear the risk of loss or damage during storage. Deferred shipment charges will be assessed from the completion date in accordance with Nevers policy for storage by the Manufacturer.

Storage by the Manufacturer

No shipment can be postponed by the customer. Nevers Industries, Inc. reserves the right to transfer products to storage and issue its invoice for the products at that time. Such transfer to storage shall be deemed delivery to the customer for all purposes. Long term storage over 30 days may be subject to surcharges.

Shipment Claims

Legal title of merchandise passes to the buyer upon acceptance by the carrier. The buyer must inspect all cartons on arrival for visible or concealed damage. In the event of visible freight damage, the buyer must make a notation on the freight bill; immediately notify Nevers for an inspection; and file a freight claim. Do not sign the receipt until the visual inspection is complete at the time of delivery. If concealed damage is discovered, Nevers must be notified within **5 days. Keep all packaging materials for inspection (do not destroy)**. Do not install damaged product. Caution: When a clear receipt is obtained by a carrier, the carrier is no longer responsible for damages or shortages. Damaged freight cannot be refused by the consignee (buyer). Processing claims for damages and shortages are the responsibility of Nevers. At no time can claims be deducted from our invoices.

Returns

All Nevers Industries, Inc. products are made to order. Therefore, merchandise may not be returned without specific consent from Nevers Customer Service Department. Unauthorized returns will be refused by the shipping department.

Miscellaneous

All merchandise shown in our catalog is the property of Nevers Industries Inc. We reserve the sole right to manufacture and distribute it. All patterns, tools, and designs developed for the production of any product will remain the property of Nevers Industries, Inc. All published dimensions are approximate and if the exact sizes are critical, we suggest that you request actual measurements. Price list data supersedes all other specifications, whether verbal or written, and may not be altered without the written consent of an officer of Nevers Industries, Inc. Typing and clerical errors on any agreement, publication, correspondence, price list, or product literature pieces are subject to correction at any time without notice. Due to variations beyond our control, all wood and upholstery products are subject to slight variations in color, texture, and grain.

Specifications

Nevers Industries, Inc. reserves the right to change prices, specifications, fabrics, dimensions and finishes at any time without prior notice. This right to change also applies to discontinuing models at any time, catalog contents and price list contents.

Warranty

Nevers Industries, Inc. warrants its products to be free from defects in material and workmanship under normal and reasonable use and service for a period of ten years from the date of shipment to customer. Proprietary supporting products, which are manufactured by others and sold by Nevers Industries, Inc., carry the original manufacturer's warranty. The decision of defects in workmanship or materials or the decision of misuse or abuse remains with Nevers Industries, Inc. No warranties other than those contained herein will be implied and Nevers Industries, Inc. does not authorize any person to create any warranties other than those contained herein.

General Specifications

Wood Veneers

Nevers® products are manufactured primarily of Plain Sliced Mahogany, Walnut, White Oak, Cherry, Ash and Maple. Other woods may be specified. Please contact Customer Service for price and availability. Veneer panels are laid up with plain sliced faces and are balanced on back to minimize warping and balance stresses.

Wood Surface Cleaning

Wood furniture should be cleaned with a damp, soft cloth, wiping in the direction of the wood grain. Wood surface should then be dried with a dry, soft cloth. Monthly, wood surfaces should be cleaned with a soft cloth using a quality wood cleaner. Following cleaner's directions, slightly dampen soft cloth and wipe in direction of wood grain. Dry the wood surface with a dry, soft cloth. Ammonia or any type of oil should be avoided.

Standard Wood Finishes

Nevers' standard finish is a multi-step process involving dyes, stain, sealer, toner and lacquer. For added protection and durability, the final top coat on all table tops is catalyzed lacquer. All of the finishes have been formulated for maximum clarity to enhance the natural characteristics of each particular wood species. Standard finish is open pore. Semi-filled and filled finishes require an upcharge and may extend the lead time. Please contact Customer Service for price and delivery date.

For other wood species, contact Customer Service for special pricing and availability.

Custom Wood Stains and Finishes

or finishes. Virtually any wood finish or color sample can be matched to your specifications. A finish sample or stain sample is required from the customer before the process of matching approval can begin. The upcharge for custom finishes varies with the type of finish and also with the quantity ordered.

Levels (Types) of Stain to Match Sample (STM) Requests

A "Custom Color only" Sample basis Standard NI Veneers and Standard Finish (20 degree satin, open pore)

- \$250 Pre-Contract
- N/C Post Contract
- Lead Time 3 - 4 business days

B "Custom Sheen" and "Custom Color" Sample basis anything other than NI Standard Top Coat (20 degree satin, open pore)

- \$500 Pre-Contract
- TBD Post Contract
- Lead Time 6 - 8 business days

C Add Alt: "Custom Veneer Spec" (Add to either "A" or "B" as applicable) basis requiring any veneer spec other than NI Standard (species or cut or matching)

- \$250 Pre-Contract
- TBD Post Contract
- Lead Time 8 - 10 business days

Costs are applicable per # of samples requested. Costs are applicable per any changes resulting in additional samples. Costs based on ground shipping only from Nevers. Customer may opt for faster shipping at own cost. Costs to customer are refundable upon receipt of a project PO, payable as a discount on final order.

Note: COLOR VARIATION WILL OCCUR IN THE GRAIN OF ALL WOOD SPECIES.

This is an inherent characteristic caused by the annual growth rings found in all hardwoods and the manner in which the boards and veneers are cut across these growth rings. In some species, this color variation is very subtle. In other species this color variation is obvious and at times radical.

The process of finishing hardwood veneers determines whether these variations are enhanced or subdued. Natural finishes will show color variations in the grain and enhance the beauty of the wood to its fullest extent. Other stains and finishes tend to blend in these variations to some extent dependent upon the depth of color and the particular method of application.

Nevers Standard Laminates

Standard, non-premium Wilsonart, Formica, Nevamar, and Pionite Laminates

Custom Laminates

Any commercially available laminate may be specified. Most custom laminate orders may extend the standard delivery date.

STANDARD STAENDE VENEER FINISHES

Wood Species and Finish Color Codes

ASH



NA - Natural Ash



WA - White Ash



CA - Cocoa Ash

CHERRY



NC - Natural Cherry



DC - Dark Cherry

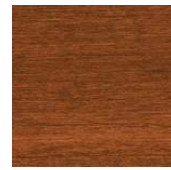

AC - Amber Cherry

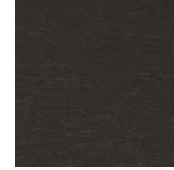

EC - Espresso Cherry



CC - Cinnamon Cherry

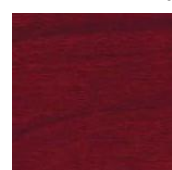

MC - Medium Cherry

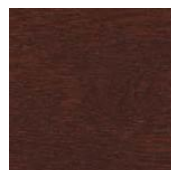

DC - Brown Cherry

MAHOGANY



LM - Light Mahogany



BM - Brown Mahogany

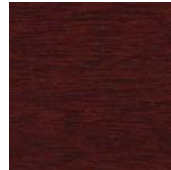

DM - Dark Mahogany

MAPLE



NP - Natural Maple

OAK



NO - Natural Oak



MO - Medium Oak



DO - Dark Oak



EO - Ebony Oak



GO - Gray Oak

WALNUT



AW - American Walnut



PW - Presidential Walnut



DW - Dark Walnut



EW - Espresso Walnut



MW - Mahogany Walnut

STANDARD STAENDE LAMINATE FINISHES



[\[LINK to Wilsonart website\]](#)

Any Wilsonart standard laminates in finishes (-38) fine velvet and (-60) matte are acceptable. Nevers may be able to use other laminates from other manufacturers'. To confirm availability and finish, contact Nevers directly.

38 - Fine Velvet Texture -

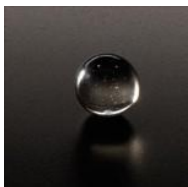

A smooth textured finish with moderate reflective value. Glossometer reading: MD and CD 14 +/- 2

60 - Matte



Textured finish with moderate reflective quality. Recommended for horizontal and vertical application. Glossometer reading: MD and CD 10 +/- 2

Corian® Solid Surface Colors



[\[LINK to Corian website\]](#)

Corian manufactures an amazing variety of brilliant colors. Nevers can apply any Corian Group C color and pricing.

HOW TO SPECIFY STAENDE TABLES

In general, Nevers tries to code specifying as follows: size part number, edge profile, base information, options, and power. There may be other considerations depending on product type. Nevers will need to know the following items to process an order help us create a Staende table quotation or to place an order.

- Indicate model number of the table (EX: **C/SLD/06042/H30**)
- Choose top and metal base combination code (EX: LW)
- Indicate veneer or plank finish code (contact us for Wilsonart laminate desired)
- Select options for your table by code: (EX: PC11/AA)
- Add other options as desired
- Separate codes with a slash

Finished Order Specification Example:

C/SLD/06042/H30/ ___#2___/___#3___/ ___#4___/ ___OPT A___/ ___OPT B___

#1 = Part Number | #2 = Top | #3 = Base Finish | #4 = Power Option | Option A | Option B

Note on Grain Direction of Tops for Wood or Laminates:

With Staende tables, the grain of the wood or laminate top goes in the direction of the longest dimension (long grain) up to tops ten feet long. After that length, grain direction runs with the shorter dimension (short grain). This is done in consideration of matching veneer flitches. Upon request, we can determine if grain directions can be matched to another preference.

Standard Staende tables are not available over 10' in length. Staende tables may be custom-ordered in with dimensions longer than 10'. This will change grain direction. Please contact Nevers directly for more information on custom Staende tables.



STÅENDE TABLE DESIGN SPECIFICATIONS

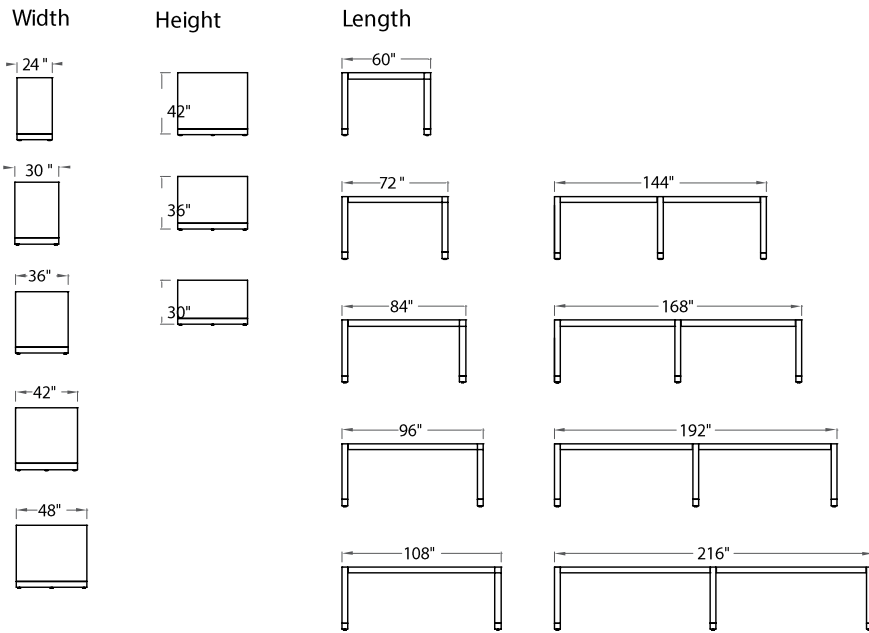

STAENDE TWO BASE (24" - 36" WIDE)



NUMBER 1 PART NUMBER	SIZE	NUMBER 2 TOP/BASE OPTION			NUMBER 3		OPTIONAL UPCHARGE - A MIRROR TOE KICK	OPTIONAL UPCHARGE - B LOCKING CASTERS
		ALL STD LAMINATE	LAMINATE TOP WOOD BASE	ALL STD WOOD	OPTIONAL UPCHARGE GLASS TOP	OPTIONAL UPCHARGE CORIAN TOP		
		AL	LW	AW	GT	CT		
24" WIDE TABLES								
C/SLD/06024/H30	60"L X 24"W X 30"H	\$5,635	\$7,032	\$8,089	\$1,752	\$2,564	\$997	N/A
C/SLD/07224/H30	72"L X 24"W X 30"H	\$5,673	\$7,079	\$8,142	\$2,077	\$2,996	\$997	N/A
C/SLD/08424/H30	84"L X 24"W X 30"H	\$5,743	\$7,167	\$8,243	\$2,400	\$3,429	\$997	N/A
C/SLD/09624/H30	96"L X 24"W X 30"H	\$5,815	\$7,256	\$8,346	\$2,725	\$3,861	\$997	N/A
C/SLD/06024/H36	60"L X 24"W X 36"H	\$5,753	\$7,179	\$8,258	\$1,752	\$2,564	\$997	N/A
C/SLD/07224/H36	72"L X 24"W X 36"H	\$5,790	\$7,226	\$8,312	\$2,077	\$2,996	\$997	N/A
C/SLD/08424/H36	84"L X 24"W X 36"H	\$5,863	\$7,316	\$8,415	\$2,400	\$3,429	\$997	N/A
C/SLD/09624/H36	96"L X 24"W X 36"H	\$5,936	\$7,406	\$8,520	\$2,725	\$3,861	\$997	N/A
C/SLD/06024/H42	60"L X 24"W X 42"H	\$5,871	\$7,326	\$8,426	\$1,752	\$2,564	\$997	N/A
C/SLD/07224/H42	72"L X 24"W X 42"H	\$5,909	\$7,373	\$8,481	\$2,077	\$2,996	\$997	N/A
C/SLD/08424/H42	84"L X 24"W X 42"H	\$5,983	\$7,466	\$8,587	\$2,400	\$3,429	\$997	N/A
C/SLD/09624/H42	96"L X 24"W X 42"H	\$6,212	\$7,752	\$8,916	\$2,725	\$3,861	\$997	N/A
30" WIDE TABLES								
C/SLD/06030/H30	60"L X 30"W X 30"H	\$5,781	\$7,213	\$8,296	\$2,092	\$3,018	\$997	\$460
C/SLD/07230/H30	72"L X 30"W X 30"H	\$5,818	\$7,260	\$8,350	\$2,498	\$3,559	\$997	\$460
C/SLD/08430/H30	84"L X 30"W X 30"H	\$5,891	\$7,350	\$8,455	\$2,903	\$4,099	\$997	\$460
C/SLD/09630/H30	96"L X 30"W X 30"H	\$5,963	\$7,442	\$8,559	\$3,309	\$4,639	\$997	\$460
C/SLD/06030/H36	60"L X 30"W X 36"H	\$5,900	\$7,363	\$8,469	\$2,092	\$3,018	\$997	\$460
C/SLD/07230/H36	72"L X 30"W X 36"H	\$5,939	\$7,411	\$8,525	\$2,498	\$3,559	\$997	\$460
C/SLD/08430/H36	84"L X 30"W X 36"H	\$6,014	\$7,504	\$8,631	\$2,903	\$4,099	\$997	\$460
C/SLD/09630/H36	96"L X 30"W X 36"H	\$6,087	\$7,597	\$8,737	\$3,309	\$4,639	\$997	\$460
C/SLD/06030/H42	60"L X 30"W X 42"H	\$6,021	\$7,513	\$8,642	\$2,092	\$3,018	\$997	N/A
C/SLD/07230/H42	72"L X 30"W X 42"H	\$6,061	\$7,563	\$8,699	\$2,498	\$3,559	\$997	N/A
C/SLD/08430/H42	84"L X 30"W X 42"H	\$6,136	\$7,657	\$8,808	\$2,903	\$4,099	\$997	N/A
C/SLD/09630/H42	96"L X 30"W X 42"H	\$6,212	\$7,752	\$8,916	\$3,309	\$4,639	\$997	N/A
36" WIDE TABLES								
C/SLD/06036/H30	60"L X 36"W X 30"H	\$5,907	\$7,293	\$8,231	\$2,450	\$3,494	\$997	\$460
C/SLD/07236/H30	72"L X 36"W X 30"H	\$5,938	\$7,310	\$8,850	\$2,936	\$4,143	\$997	\$460
C/SLD/08436/H30	84"L X 36"W X 30"H	\$6,001	\$7,385	\$8,941	\$3,422	\$4,791	\$997	\$460
C/SLD/09636/H30	96"L X 36"W X 30"H	\$6,065	\$7,466	\$9,037	\$3,908	\$5,438	\$997	\$460
C/SLD/10836/H30	108"L X 36"W X 30"H	\$7,912	\$9,527	\$10,952	N/A	\$6,087	\$997	N/A
C/SLD/12036/H30	120"L X 36"W X 30"H	N/A	N/A	N/A	N/A	N/A	N/A	N/A
C/SLD/06036/H36	60"L X 36"W X 36"H	\$6,036	\$7,450	\$8,408	\$2,450	\$3,494	\$997	\$460
C/SLD/07236/H36	72"L X 36"W X 36"H	\$6,067	\$7,467	\$9,039	\$2,936	\$4,143	\$997	\$460
C/SLD/08436/H36	84"L X 36"W X 36"H	\$6,131	\$7,545	\$9,132	\$3,422	\$4,791	\$997	\$460
C/SLD/09636/H36	96"L X 36"W X 36"H	\$6,259	\$7,701	\$9,320	\$3,908	\$5,438	\$997	\$460
C/SLD/10836/H36	108"L X 36"W X 36"H	\$8,086	\$9,735	\$11,190	N/A	\$6,087	\$997	N/A
C/SLD/12036/H36	120"L X 36"W X 36"H	N/A	N/A	N/A	N/A	N/A	N/A	N/A
C/SLD/06036/H42	60"L X 36"W X 42"H	\$6,164	\$7,608	\$8,586	\$2,450	\$3,494	\$997	\$460
C/SLD/07236/H42	72"L X 36"W X 42"H	\$6,196	\$7,625	\$9,229	\$2,936	\$4,143	\$997	\$460
C/SLD/08436/H42	84"L X 36"W X 42"H	\$6,261	\$7,704	\$9,325	\$3,422	\$4,791	\$997	\$460
C/SLD/09636/H42	96"L X 36"W X 42"H	\$6,326	\$7,784	\$9,420	\$3,908	\$5,438	\$997	\$460
C/SLD/10836/H42	108"L X 36"W X 42"H	\$8,257	\$9,940	\$11,424	N/A	\$6,087	\$997	N/A
C/SLD/12036/H42	120"L X 36"W X 42"H	N/A	N/A	N/A	N/A	N/A	N/A	N/A

STAENDE TWO BASE DESIGN (CONT.; 42" - 48" WIDE)



NUMBER 1 PART NUMBER	SIZE	NUMBER 2 TOP/BASE OPTION			NUMBER 3		OPTIONAL UPCHARGE - A MIRROR TOE KICK MT	OPTIONAL UPCHARGE - B LOCKING CASTERS LC
		ALL STD LAMINATE AL	LAMINATE TOP WOOD BASE LW	ALL STD WOOD AW	OPTIONAL UPCHARGE GLASS TOP GT	OPTIONAL UPCHARGE CORIAN TOP CT		
		42" WIDE TABLES						
C/SLD/06042/H30	60"L X 42"W X 30"H	\$6,108	\$7,471	\$9,508	\$2,806	\$3,969	\$997	\$460
C/SLD/07242/H30	72"L X 42"W X 30"H	\$6,142	\$7,512	\$9,560	\$3,373	\$4,726	\$997	\$460
C/SLD/08442/H30	84"L X 42"W X 30"H	\$6,177	\$7,553	\$9,612	\$3,940	\$5,482	\$997	\$460
C/SLD/09642/H30	96"L X 42"W X 30"H	\$6,210	\$7,594	\$9,664	\$4,508	\$6,238	\$997	\$460
C/SLD/10842/H30	108"L X 42"W X 30"H	\$8,540	\$9,912	\$11,865	N/A	\$6,995	\$997	N/A
C/SLD/12042/H30	120"L X 42"W X 30"H	\$8,586	\$9,965	\$11,927	N/A	\$7,752	\$997	N/A
C/SLD/06042/H36	60"L X 42"W X 36"H	\$6,244	\$7,635	\$9,715	\$2,806	\$3,969	\$997	\$460
C/SLD/07242/H36	72"L X 42"W X 36"H	\$6,277	\$7,676	\$9,767	\$3,373	\$4,726	\$997	\$460
C/SLD/08442/H36	84"L X 42"W X 36"H	\$6,311	\$7,717	\$9,819	\$3,940	\$5,482	\$997	\$460
C/SLD/09642/H36	96"L X 42"W X 36"H	\$6,345	\$7,757	\$9,870	\$4,508	\$6,238	\$997	\$460
C/SLD/10842/H36	108"L X 42"W X 36"H	\$8,632	\$10,018	\$11,990	N/A	\$6,995	\$997	N/A
C/SLD/12042/H36	120"L X 42"W X 36"H	\$8,677	\$10,069	\$12,053	N/A	\$7,752	\$997	N/A
C/SLD/06042/H42	60"L X 42"W X 42"H	\$6,378	\$7,798	\$9,922	\$2,806	\$3,969	\$997	\$460
C/SLD/07242/H42	72"L X 42"W X 42"H	\$6,412	\$7,840	\$9,974	\$3,373	\$4,726	\$997	\$460
C/SLD/08442/H42	84"L X 42"W X 42"H	\$6,446	\$7,880	\$10,025	\$3,940	\$5,482	\$997	\$460
C/SLD/09642/H42	96"L X 42"W X 42"H	\$6,479	\$7,921	\$10,077	\$4,508	\$6,238	\$997	\$460
C/SLD/10842/H42	108"L X 42"W X 42"H	\$8,722	\$10,122	\$12,114	N/A	\$6,995	\$997	N/A
C/SLD/12042/H42	120"L X 42"W X 42"H	\$8,813	\$10,227	\$12,240	N/A	\$7,752	\$997	N/A
48" WIDE TABLES								
C/SLD/06048/H30	60"L X 48"W X 30"H	\$6,238	\$7,629	\$9,709	\$3,146	\$4,423	\$997	\$460
C/SLD/07248/H30	72"L X 48"W X 30"H	\$6,273	\$7,670	\$9,761	\$3,795	\$5,288	\$997	\$460
C/SLD/08448/H30	84"L X 48"W X 30"H	\$6,307	\$7,712	\$9,814	\$4,443	\$6,152	\$997	\$460
C/SLD/09648/H30	96"L X 48"W X 30"H	\$6,342	\$7,754	\$9,866	\$5,091	\$7,017	\$997	\$460
C/SLD/10848/H30	108"L X 48"W X 30"H	\$8,720	\$10,120	\$12,112	N/A	\$7,880	\$997	N/A
C/SLD/12048/H30	120"L X 48"W X 30"H	\$8,766	\$10,174	\$12,176	N/A	\$8,745	\$997	N/A
C/SLD/06048/H36	60"L X 48"W X 36"H	\$6,376	\$7,796	\$9,919	\$3,146	\$4,423	\$997	\$460
C/SLD/07248/H36	72"L X 48"W X 36"H	\$6,411	\$7,838	\$9,972	\$3,795	\$5,288	\$997	\$460
C/SLD/08448/H36	84"L X 48"W X 36"H	\$6,445	\$7,879	\$10,024	\$4,443	\$6,152	\$997	\$460
C/SLD/09648/H36	96"L X 48"W X 36"H	\$6,479	\$7,921	\$10,077	\$5,091	\$7,017	\$997	\$460
C/SLD/10848/H36	108"L X 48"W X 36"H	\$8,813	\$10,227	\$12,240	N/A	\$7,880	\$997	N/A
C/SLD/12048/H36	120"L X 48"W X 36"H	\$8,859	\$10,281	\$12,304	N/A	\$8,745	\$997	N/A
C/SLD/06048/H42	60"L X 48"W X 42"H	\$6,513	\$7,963	\$10,130	\$3,146	\$4,423	\$997	\$460
C/SLD/07248/H42	72"L X 48"W X 42"H	\$6,548	\$8,005	\$10,183	\$3,795	\$5,288	\$997	\$460
C/SLD/08448/H42	84"L X 48"W X 42"H	\$6,582	\$8,047	\$10,236	\$4,443	\$6,152	\$997	\$460
C/SLD/09648/H42	96"L X 48"W X 42"H	\$6,617	\$8,088	\$10,288	\$5,091	\$7,017	\$997	\$460
C/SLD/10848/H42	108"L X 48"W X 42"H	\$8,906	\$10,333	\$12,367	N/A	\$7,880	\$997	N/A
C/SLD/12048/H42	120"L X 48"W X 42"H	\$8,998	\$10,441	\$12,495	N/A	\$8,745	\$997	N/A

STAENDE THREE BASE PRICING



NUMBER 1	PART NUMBER	SIZE	NUMBER 2 TOP/BASE OPTION			NUMBER 3			
			ALL STD LAMINATE	LAMINATE TOP WOOD BASE	ALL STD WOOD	OPTIONAL UPCHARGE	OPTIONAL UPCHARGE	OPTIONAL UPCHARGE - A	OPTIONAL UPCHARGE - B
			AL	LW	AW	GLASS TOP	CORIAN TOP	MIRROR TOE KICK	LOCKING CASTERS
36" WIDE TABLES									
C/SLD/14436/H30	144"L X 36"W X 30"H	\$10,619	\$12,881	\$14,861	\$5,691	\$7,816	\$1,736	\$690	
C/SLD/16836/H30	168"L X 36"W X 30"H	\$10,676	\$12,949	\$14,940	\$6,664	\$9,112	\$1,736	\$690	
C/SLD/19236/H30	192"L X 36"W X 30"H	\$10,732	\$13,017	\$15,018	\$7,636	\$10,409	\$1,736	\$690	
C/SLD/21636/H30	216"L X 36"W X 30"H	\$10,788	\$13,086	\$15,098	N/A	\$11,706	\$1,736	N/A	
C/SLD/14436/H36	144"L X 36"W X 36"H	\$10,844	\$13,154	\$15,176	\$5,691	\$7,816	\$1,736	\$690	
C/SLD/16836/H36	168"L X 36"W X 36"H	\$10,900	\$13,222	\$15,255	\$6,664	\$9,112	\$1,736	\$690	
C/SLD/19236/H36	192"L X 36"W X 36"H	\$10,956	\$13,290	\$15,333	\$7,636	\$10,409	\$1,736	\$690	
C/SLD/21636/H36	216"L X 36"W X 36"H	\$11,012	\$13,358	\$15,412	N/A	\$11,706	\$1,736	N/A	
C/SLD/14436/H42	144"L X 36"W X 42"H	\$11,068	\$13,427	\$15,490	\$5,691	\$7,816	\$1,736	\$690	
C/SLD/16836/H42	168"L X 36"W X 42"H	\$11,125	\$13,495	\$15,569	\$6,664	\$9,112	\$1,736	\$690	
C/SLD/19236/H42	192"L X 36"W X 42"H	\$11,182	\$13,563	\$15,648	\$7,636	\$10,409	\$1,736	\$690	
C/SLD/21636/H42	216"L X 36"W X 42"H	\$11,238	\$13,631	\$15,727	N/A	\$11,706	\$1,736	N/A	
42" WIDE TABLES									
C/SLD/14442/H30	144"L X 42"W X 30"H	\$10,839	\$13,148	\$15,169	\$6,582	\$9,005	\$1,736	\$690	
C/SLD/16842/H30	168"L X 42"W X 30"H	\$10,897	\$13,218	\$15,249	\$7,717	\$10,517	\$1,736	\$690	
C/SLD/19242/H30	192"L X 42"W X 30"H	\$10,954	\$13,288	\$15,330	\$8,852	\$12,030	\$1,736	\$690	
C/SLD/21642/H30	216"L X 42"W X 30"H	\$11,011	\$13,357	\$15,410	N/A	\$13,543	\$1,736	N/A	
C/SLD/14442/H36	144"L X 42"W X 36"H	\$11,068	\$13,427	\$15,490	\$6,582	\$9,005	\$1,736	\$690	
C/SLD/16842/H36	168"L X 42"W X 36"H	\$11,127	\$13,496	\$15,571	\$7,717	\$10,517	\$1,736	\$690	
C/SLD/19242/H36	192"L X 42"W X 36"H	\$11,184	\$13,566	\$15,651	\$8,852	\$12,030	\$1,736	\$690	
C/SLD/21642/H36	216"L X 42"W X 36"H	\$11,241	\$13,636	\$15,731	N/A	\$13,543	\$1,736	N/A	
C/SLD/14442/H42	144"L X 42"W X 42"H	\$11,298	\$13,705	\$15,811	\$6,582	\$9,005	\$1,736	\$690	
C/SLD/16842/H42	168"L X 42"W X 42"H	\$11,355	\$13,774	\$15,892	\$7,717	\$10,517	\$1,736	\$690	
C/SLD/19242/H42	192"L X 42"W X 42"H	\$11,413	\$13,844	\$15,972	\$8,852	\$12,030	\$1,736	\$690	
C/SLD/21642/H42	216"L X 42"W X 42"H	\$11,470	\$13,914	\$16,052	N/A	\$13,543	\$1,736	N/A	
48" WIDE TABLES									
C/SLD/14448/H30	144"L X 48"W X 30"H	\$11,004	\$13,349	\$15,400	\$7,473	\$10,194	\$1,736	\$690	
C/SLD/16848/H30	168"L X 48"W X 30"H	\$11,063	\$13,419	\$15,483	\$8,770	\$11,922	\$1,736	\$690	
C/SLD/19248/H30	192"L X 48"W X 30"H	\$11,121	\$13,489	\$15,564	\$10,067	\$13,651	\$1,736	\$690	
C/SLD/21648/H30	216"L X 48"W X 30"H	\$11,179	\$13,561	\$15,645	N/A	\$15,380	\$1,736	N/A	
C/SLD/14448/H36	144"L X 48"W X 36"H	\$11,238	\$13,631	\$15,727	\$7,473	\$10,194	\$1,736	\$690	
C/SLD/16848/H36	168"L X 48"W X 36"H	\$11,296	\$13,702	\$15,808	\$8,770	\$11,922	\$1,736	\$690	
C/SLD/19248/H36	192"L X 48"W X 36"H	\$11,354	\$13,772	\$15,890	\$10,067	\$13,651	\$1,736	\$690	
C/SLD/21648/H36	216"L X 48"W X 36"H	\$11,411	\$13,844	\$15,971	N/A	\$15,380	\$1,736	N/A	
C/SLD/14448/H42	144"L X 48"W X 42"H	\$11,470	\$13,914	\$16,052	\$7,473	\$10,194	\$1,736	\$690	
C/SLD/16848/H42	168"L X 48"W X 42"H	\$11,528	\$13,984	\$16,134	\$8,770	\$11,922	\$1,736	\$690	
C/SLD/19248/H42	192"L X 48"W X 42"H	\$11,586	\$14,055	\$16,215	\$10,067	\$13,651	\$1,736	\$690	
C/SLD/21648/H42	216"L X 48"W X 42"H	\$11,645	\$14,125	\$16,297	N/A	\$15,380	\$1,736	N/A	

STÅENDE TABLE OPTIONS

Base Options for Staende Tables



Tapered Legs

General Options for Standard Staende Tables



Corian



Back Painted Glass



Mirror Aluminum
Toe Kick



Locking Casters

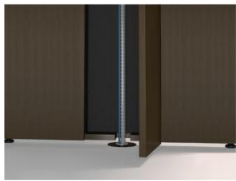

Core Drill Access



Apron Power / USB Charging

Standard Power Options



Power
(Black, White Grey)



1 USB Charging
(Black, White Grey)



Cat6
(Black or White Only)



1 HDMI
(Black or White Only)

TABLE TOP POWER IT/AV OPTIONS			
MODEL #	DESCRIPTION	LIST PRICE	QTY
PC11/AA	Two-sided unit, each side has: (2) power, (1) dual USB charging, and (1) open position	\$1,307	each
PC11/BB	Each Side Contains 2 Power outlets, 1 Port with 2 USB Charging, 1 HDMI on One Side, 1 RJ45 Cat 6 Data on the Other. PC11 Comes Standard with 120" 15 Amp Cord.	\$1,487	each



C/PC11/AA

PERIMETER POWER IT/AV OPTIONS			
MODEL #	DESCRIPTION	LIST PRICE	QTY
SPP/POW	Power Port for Perimeter w/ Power Block, Jumper, & Infeed	\$316	each
SPP/USB	USB Charging Port w/ Power Block for Perimeter	\$347	each
SPP/CAT6	CAT6 Port for Perimeter	\$187	each
SPP/HDMI	HDMI Port for Perimeter	\$187	each



 **NEVERS**[®]
WORK IN STYLE

6845 Wedgwood Court N | Maple Grove, MN 55311 | 800.242.2443 | FX 800.258.5591 | NEVERS.COM

