

Simple™

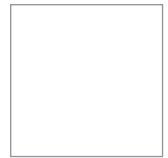

Collection features and benefits ..... 3  
 Terms and conditions ..... 4-5  
 General specifications ..... 6-7  
 Power/voice/data/av (PVD) service center ..... 8-9  
 Articulating table tops and bases ..... 10  
 Meeting Link™ for articulating tables ..... 11

**Simple™ Conference Table Tops and Bases**

Round tables ..... 12  
 Small rectangle tables ..... 13  
 Electrical system for conference tables ..... 13  
 Rectangle tables ..... 14  
 Arc rectangle tables ..... 15  
 Boat tables ..... 16  
 Arc boat tables ..... 17  
 Racetrack tables ..... 18  
 Viewpoint tables ..... 19

**Simple™ Elements**

Storage credenzas/e-credenzas ..... 20  
 Storage/display cabinets ..... 20  
 Finishing tops ..... 20  
 Buffet shelf ..... 20  
 Buffet credenzas ..... 21  
 Low credenzas ..... 22  
 Wall mount buffet ..... 22  
 Porcelain boards ..... 22  
 Mount for plasma monitor ..... 23  
 Hospitality cart ..... 23  
 Lectern ..... 21  
 Visual boards ..... 21

**Simple™ Preconfigured**

Storage credenzas ..... 24-25  
 Buffet credenzas ..... 24  
 Mediawall ..... 24  
 Storage/display cabinets ..... 25

## Configured Your Way

That is the reason that Nevers introduced the Simple Collection. To allow you to easily specify the required product configurations and to easily specify multi-functional meeting and conferencing rooms with flexible products.

The key to Simple is interchangeable components in multiple sizes and finishes which perfectly suit any small enclave, team room, project room, full scale meeting or conference room.

It's also beautiful. Simple furniture is striking to look at in every finish and configuration. We build it to your specifications in the size, configuration, finish color, and base you select for the customers' space. Its design is cleanly contemporary and enduringly classic. Casegood tops and door fronts are offered in frosted glass, silver colorcoat and wood finishes. Table legs are produced in aluminum and wood and effectively house power cabling for the discreet containment of electrical and data cords. You can choose one piece or build entire rooms to your exact specifications knowing that the design is clean, current and capable.

## Conference Tables

The Simple Conference Tables are stylized in a cleanly contemporary design that compliments any design format. The support structure allows all cabling for power and AV to be installed prior to the table top being attached. This eliminates damage to the top during installation and significantly reduces the complexity of cable routing and installation time.

## Casegoods

Casegoods represent the ultimate form of multiplicity from simplicity. The collection consists of multiple versions of single wide and double wide cabinets that can be specified in an unlimited number of configurations with varying door materials and cabinet top options. The cabinets are designed to be specified and used in two ways. The first is as modular furniture. The cabinets may be specified as stand-alone modules that are simply butted together at installation to form the required piece—credenza, mediawall, storage tower. Modular cabinets enhance the contemporary styling of the space and allow the end user maximum flexibility for future growth, such as reconfiguring the room or using the cabinets in other rooms.

Secondly, the Simple cabinets may be specified with a common connecting top. This maintains the ease of configuring the cabinets to the customers' requirements, while presenting a more traditional single piece furniture appearance. For ease of specifying, the Simple cabinets are also offered as preconfigured cabinets in the most commonly requested configurations. It's simple, and it's specification-friendly. If you are in a hurry, let us plan the room for you with individual pieces specified and floor-planned in multi-application formats. That's simple, too.

The Simple Casegoods are offered in two depths. The 16" depth is the preferred cabinet for smaller rooms. The 22" depth is scaled for larger rooms and rooms requiring AV components and power accommodations. The double wide 22" deep e-cabinets are vented and ready to accept a rack mount for AV components. For simplicity in ordering and security for the end user, cabinets are standard with locks. Locks are not available on glass door cabinets.

As an added bonus, you will find the furniture in the Simple Collection to be competitively priced. The Simple Collection maintains our reputation for "high quality product designs, crafted only with the highest qualities of material and workmanship and delivered trouble-free as promised". It is through design engineering that we are able to offer the Simple Collection at surprisingly competitive pricing.

### **Credit and Payment Terms**

Nevers Industries Inc policy does not allow for automatic open account terms for new customers, customers whose account is not current, individuals or residential accounts. *New customers are required to make a deposit for the full value of the merchandise ordered.* A credit application will be sent to each new customer. Credit will be established upon review of the responses given by the customer's references and will appear on future order acknowledgements. New customers are encouraged to begin establishing a credit rating with Nevers Industries Inc prior to placing an order. Our customers are responsible to provide the necessary current and accurate information. *Upon establishment of an open account, terms are Net 30. 1 1/2% per month service charge will be added to all past due accounts. Accounts that are 90 days past due will be subject to collection proceedings without any additional notice. Orders will not be processed for past due accounts until the amount due, including any service charges, is paid in full.* Standard product orders exceeding \$50,000 net will require a down payment of 33%. Custom orders will require a down payment of 50% and will not be scheduled for production until the down payment is received. Balance is then due before shipment. *A bank letter of credit may be required for any order over \$50,000 net.*

### **Prices**

Our prices are list, freight prepaid, F.O.B. Plymouth, Minnesota, and are subject to change without notice. Quoted prices must be accepted within 30 days or re-quoted for date and approval. Freight is prepaid and allowed for normal ground transportation within the 48 contiguous states, must ship to dock location. Air freight, will calls, and special delivery will be quoted and invoiced separately. Prices do not include installation, storage, or sales tax.

### **Packaging**

Nevers Industries Inc pricing includes packing for North American shipment. Whenever possible, Nevers will blanket-wrap your order; otherwise, all products will be packaged. Only environmentally safe packing materials are used. Large furniture pieces will be packed with wood reinforcements for added protection. For special packaging, crating or overseas shipment, please contact our Customer Service Department.

### **Delivery**

Nevers Industries Inc will select the method of shipment, carrier and routing. Carrier selection is solicited to provide the best service to each customer in their particular location. All shipments are sent prepaid, FOB Plymouth, Minnesota. *Nevers Industries Inc liability ends when the carrier issues a receipt to Nevers Industries Inc. This is an acknowledgement by the transportation company that the shipment has been received by the freight company in good condition and title of*

*the goods and risk of loss transfers to the buyer. The order shall be considered complete. Prepaid freight does not change the F.O.B. status of the product and risks involved in the shipment. We reserve the right to make partial shipments. Invoices relevant to the partial shipments are payable as they fall due.*

### **Freight Terms**

All orders under \$2,000 net are subject to a minimum order/ additional freight charge of \$100 net; Nevers Industries Inc also reserves the right to establish a freight and fuel surcharge fee to cover variable freight costs. This charge will be established at the time of order and acknowledgement date.

### **Lead Times**

The lead time on an order begins when Nevers' Order Entry Department has verified the validity of the items ordered and has received at our manufacturing facility all COM materials supplied by others. All acknowledgments will contain current lead time information. If for some reason the buyer does not want it early, please list a Do Not Ship before date. We are not responsible for delays in scheduling or failure to make scheduled shipping date due to strikes, lockouts or other labor complications, war, riots, Acts of God, fires, accidents, restraints affecting shipment or credit, reduced supply or excessive cost of fuel or raw material, delays from suppliers, compliance with Government regulations, or other unforeseen contingencies. When delays in product delivery are caused by the purchaser, we reserve the right to draw up to 100% of the contract price and to charge to the purchaser any costs incurred by us due to such.

### **Order Acknowledgement**

All orders are subject to final acceptance by Nevers Industries, Inc. Receipt of our acknowledgement indicates acceptance of your order subject to the terms and conditions set forth in Our Acknowledgement. If pricing on the purchase order is different than the acknowledged pricing, the acknowledgement will take precedent over the purchase order. Nevers Industries, Inc. attempts to clarify all orders. But in the event of any discrepancy, please notify Nevers Industries Inc immediately. Failure to notify Nevers of a discrepancy within five (5) days will constitute acceptance of the order as acknowledged. All orders are subject to credit approval at any time.

### **Change Orders**

Nevers Industries, Inc. will make every attempt to honor any reasonable change request to standard product provided that the request is received prior to start of production. Change orders will be accepted only if the request is made in writing and received in time to make the change. Nevers Industries, Inc. reserves the right to increase our

acknowledged price and ship date if necessary to make the requested changes.

Nevers Industries Inc will make every reasonable effort to stop production, scheduling shipments, etc., upon receipt of written notification of changes, cancellations, or deferments of delivery. Nevers will assess charges to the customer for change orders, cancellations, and delivery deferments as stipulated in the following:

#### Change Orders:

- Received prior to start of production will be charged \$200 net.
- Received after production has started involving design changes or reductions in quantity will not be accepted. The customer will receive the goods as ordered and be liable for the amount due.

#### Cancellations:

- Received prior to start of production will be assessed a \$500 net cancellation charge.
- Received after production has started will be assessed the total accumulated cost of the project plus a \$500 net cancellation charge.

#### Deferred Shipments

All merchandise will ship upon completion of production. If customer is unable to take delivery of merchandise when ready for shipment, Nevers Industries, Inc. may transfer the merchandise to storage. All cost for storage and freight will be at customer's expense. Transfer to storage will be considered delivery for all purposes including invoicing and payment. Customer will bear the risk of loss or damage during storage. Deferred shipment charges will be assessed from the completion date in accordance with Nevers policy for Storage by the Manufacturer.

#### Storage By The Manufacturer

No shipment can be postponed by the customer. Nevers Industries Inc reserves the right to transfer products to storage and issue its invoice for the products at that time. Such transfer to storage shall be deemed delivery to the customer for all purposes. Long term storage over 30 days may be subject to surcharges.

#### Shipment Claims

Legal title of merchandise passes to the buyer upon acceptance by the carrier. The buyer must inspect all cartons on arrival for visible or concealed damage. In the event of visible freight damage, the buyer must make a notation on the freight bill; immediately notify the carrier for an inspection; and file a freight claim. *Do not sign the receipt until the visual inspection is complete at the time of delivery. If concealed damage is discovered, the carrier must be notified*

within 15 days. Keep all packaging materials for inspection (do not destroy). The buyer has the sole obligation of seeking recourse against the carrier. Caution: When a clear receipt is obtained by a carrier, the carrier is no longer responsible for damages or shortages. Damaged freight cannot be refused by the consignee (buyer). Processing claims for damages and shortages are the responsibility of the buyer. At no time can claims be deducted from our invoices.

#### Returns

All Nevers Industries, Inc. products are made to order. Therefore, merchandise may not be returned without specific consent from Nevers Customer Service Department. Unauthorized returns will be refused by the shipping department.

#### Miscellaneous

All merchandise shown in our catalog is the property of Nevers Industries Inc. We reserve the sole right to manufacture and distribute it. All patterns, tools, and designs developed for the production of any product will remain the property of Nevers Industries Inc. All published dimensions are approximate and if the exact sizes are critical, we suggest that you request actual measurements. Price list data supersedes all other specifications, whether verbal or written, and may not be altered without the written consent of an officer of Nevers Industries Inc. Typing and clerical errors on any agreement, publication, correspondence, price list, or product literature pieces are subject to correction at any time without notice. Due to variations beyond our control, all wood and upholstery products are subject to slight variations in color, texture, and grain.

#### Specifications

Nevers Industries, Inc. reserves the right to change prices, specifications, fabrics, dimensions and finishes at any time without prior notice. This right to change also applies to discontinuing models at any time, catalog contents and price list contents.

#### Warranty

Nevers Industries, Inc. warrants its products to be free from defects in material and workmanship under normal and reasonable use and service for a period of ten years from the date of shipment to customer. Proprietary supporting products, which are manufactured by others and sold by Nevers Industries, Inc. carry the original manufacturer's warranty. The decision of defects in workmanship or materials or the decision of misuse or abuse remains with Nevers Industries, Inc. No warranties other than those contained herein will be implied and Nevers Industries, Inc. does not authorize any person to create any warranties other than those contained herein.

**AWI “A” Grade Wood Veneers**

Simple products are crafted in “A” grade wood veneers available in Mahogany, Black Walnut, White Oak, Cherry and Maple. Veneer panels are 3-ply balanced construction, are laid up with plain sliced face veneers and are balanced on back to minimize warping and to balance natural stresses. Cores are either 45# particleboard, or 55# medium density fiberboard, per ANSI standards 208.1 or 208.2. Face veneers meet or exceed AWI custom standards and are “A” grade. All “A” face veneers are center matched and either book or slip matched and are laid up to Nevers’ custom specifications.

**Wood Veneer Finishes**

Standard wood veneers finishing process is a multi-step procedure involving dyes, stains, toners, sealers, lacquer. For added protection and durability, the final topcoat on all horizontal surfaces is a catalyzed-blended, lacquer/ varnish finish. All finishing processes have been formulated to provide maximum durability and clarity, and to enhance the natural characteristics of each particular wood species. Standard finish is open pore. Semi-filled and filled finishes require an up charge and may extend the lead-time. Please contact Customer Service for pricing and availability on these and other wood species.

Note: Color variation will occur in the grain of all wood species. This is an inherent characteristic caused by the annual growth rings found in all hardwoods and by the manner in which the boards and veneers are cut across these growth rings. In some species, this color variation is very subtle. In other species this color variation is obvious and at times radical.

The process of finishing hardwood veneers determines whether these variations are enhanced or subdued. Natural finishes will show color variations in the grain and enhance the beauty of the wood to its fullest extent. Other stains, toners, and finishes tend to blend these variations, dependent upon the depth of color and the particular method of application.

**Color Index for AWI “A” Grade Wood Veneers**

Wood Species and Colors

<b>Oak</b>		<b>Walnut</b>	
Natural Oak	NO	American Walnut	AW
Medium Oak	MO	Dark Walnut	DW
Dark Oak	DO	Mahogany on Walnut	MW
Ebony on Oak	EO	Presidential Walnut	PW
		Espresso Walnut	EW

<b>Mahogany</b>		<b>Cherry</b>	
Light Mahogany	LM	Natural Cherry	NC
Brown Mahogany	BM	Amber Cherry	AC
Dark Mahogany	DM	Brown Cherry	BC
		Medium Cherry	MC
		Dark Cherry	DC
		Espresso Cherry	PC
		Cinnamon Cherry	CC

<b>Maple</b>		<b>Ash</b>	
Natural Maple	NP	Natural Ash	NA
Golden Maple	GP	Cocoa Ash	CA
Copper Maple	PP		
Autumn Maple	TP		
Ebony Maple	EP		
Honey Maple	YP		

<b>Beech</b>	
Natural Beech	NB

### **Custom Wood Colors and Finishes**

Nevers offers the capability of matching your custom stains or finishes. Virtually any wood finish or color sample can be matched to your specifications. A finish or stain sample is required before the process of matching approval can begin. The upcharge for custom finishes varies with the type of finish and also with the quantity ordered. Please contact Customer Service for pricing and availability. For custom stain/color match—any order under \$2000 net there is a \$270 net up charge. Engineered wood veneers cannot be custom stained.

### **Color Index for Engineered Veneers**

Wood Pattern and Colors

### **ColorCoat**

Standard ColorCoat is a painted wood core of 48# medium density fiberboard, per ANSI standards 208.1 or 208.2. Special colors are available and may require an up charge and extend lead-time. Please contact Customer Service for pricing and availability.

### **Optional Glass Tops**

Credenza glass tops are 3/8" thick and are etched on the back for a semi-transparent appearance. Optional adjustable glass shelves are clear. Optional buffet shelf glass tops are 1/2" thick and are etched on the back for a semitransparent appearance. HydroShield™ fingerprint protectant can be applied for \$17.00 per square foot. Call Customer Service for details.

### **ColorCoat and Metal Colors**

Simple products ship standard with Silver Fog colorcoat and Platinum metal. For other colors please contact our Customer Service Department at **800-242-2443**.

Fabric Color for Visual Boards

Any C.F. Stinson—Pattern "Mira" series may be specified. If not specified, ships standard with Shadow.

### **Furniture Care, Cleaning and Maintenance Instructions**

#### **WOOD SURFACES**

Your Nevers' furniture requires only minimal care to ensure years of lasting beauty and performance. Any spilled liquids should be wiped up immediately with a dry soft cloth. On a weekly basis dust the wood surface, then clean with a damp, soft cloth, wiping in the direction of the wood grain. Surface should then be dried with a dry, soft cloth. On a semi-annual basis, after the weekly cleaning, clean the wood surfaces with a quality wood cleaner such as Guardsman Wood Cleaner. Products containing oil, ammonia or silicon should not be used. For specific questions about Furniture Care, Cleaning and Maintenance, contact Nevers Customer Service at **800-242-2443**.

## UNDERSTANDING NEVERS MEETING LINK™

The Nevers Meeting Link System is comprised of Technology Centers and Power Centers

### Technology Centers

Technology Centers conform to UL 183, 20 AMP plug is the standard for manufactured electrical systems. Nevers proprietary Technology Centers use modular power connections, are daisy chainable and are ideal for all installations where multiple electrical outlets connect to a single power in-feed. They are available in single or multiple circuits. Technology Centers can be hardwired or connected with a molded plug. Data and AV are easily integrated in Technology Centers.

**INSTALLATION:** Technology Centers are installed in the table base system *before* the top is placed. This provides electrical, data and audio visual contractors a convenient, well lit work area. The table top is placed on the base system *after* technology integration is complete. This helps prevent table top damage attributable to third party contractors.

### Power Centers

Power Centers conform to UL962A , the standard for furniture power distribution units. Power centers connect directly to a power outlet with a molded plug. Power Centers are a flexible, cost effective solution for mobile or light duty applications. Power Centers do not connect in series. Data and basic AV connections are easily integrated in Power Centers.

**INSTALLATION:** Power Centers drop through the table top. They are the last part of the table to be installed. This is a quick and simple installation process for light duty power/voice/data applications.

### Pre-Configured Meeting Link™

Nevers offers pre-configured Meeting Link solutions for all tables. This is an easy, trouble free method to specify power, voice and data connections. Whether you have light, medium or heavy applications, there is a convenient pre-configured solution.

### Custom Meeting Link™

Meeting Link can be custom configured to meet any specific requirement. All Meeting Link products are available "a la cart" so you can develop a system that meets your clients exact needs.

### TECHNOLOGY CENTERS

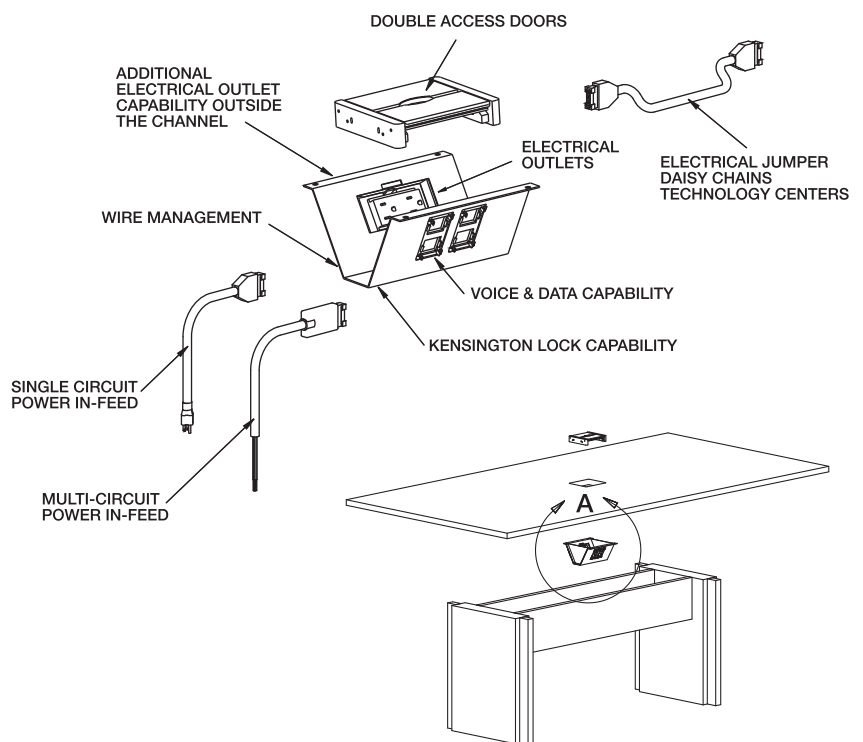

### POWER CENTERS

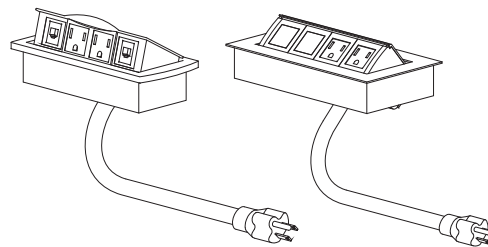

**Preconfigured Meeting Link™ System 3: Light Capacity**

Technology Center Dimensions: 8"l x 6"w

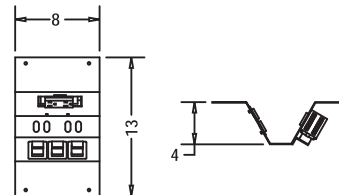

Table Length	Number of Technology Centers	Electrical Outlets	Voice, Data and AV Port Capacity
8'	1	2	6
10'	1	2	6
12'	2	4	12
14'	2	4	12
16'	2	4	12
18'	2	4	12
20'	3	6	18
22'	3	6	18
24'	3	6	18
26'	4	8	24

**Technology Centers for Customizing Meeting Link™ Capacities**

Please note – location drawing required\*

Technology Center Dimension	Number of Electrical Outlets	Voice, Data and AV Port Capacity
8"l x 6"w	2	6
12"l x 6"w	2	6

\* A drawing of the table top with the location of each Technology Center is required. If ordering multiple Technology Centers for 1 table, specify on drawing if ganging is required. For additional assistance in specifying/ordering Technology Centers, please contact customer service at 800.242.2443.

# Simple™ articulating table tops and bases

## arc boat tables



48" wide x 39" wide ends			wood projector end with silver metal C leg	modesty panels 12" high MP	meeting link for full table 03	meeting link for presentation end only 02
Length	Size	Model Number	Price	Price	Price	Price
8'	96" x 48"	M/E1/TAO/09648	<b>\$8,818</b>	<b>\$1,621</b>	<b>\$2,009</b>	<b>\$670</b>
10"	120" x 48"	M/E1/TAO/12048	<b>9,467</b>	<b>1,715</b>	<b>2,009</b>	<b>670</b>
12"	144" x 48"	M/E1/TAO/14448	<b>10,419</b>	<b>1,997</b>	<b>2,009</b>	<b>670</b>
14"	168" x 48"	M/E1/TAO/16848	<b>12,274</b>	<b>2,262</b>	<b>3,348</b>	<b>670</b>

## connector table

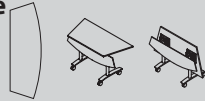

stationary top			with silver metal C leg	modesty panels 12" high MP
Length	Size	Model Number	Price	Price
4'	48" x 24"	M/E1/TCO/04824/ST	<b>\$2,100</b>	<b>\$782</b>
5"	60" x 24"	M/E1/TCO/06024/ST	<b>2,217</b>	<b>860</b>
6"	72" x 24"	M/E1/TCO/07224/ST	<b>2,346</b>	<b>909</b>

## flip top

4'	96" x 48"	M/E1/TCO/04824/FT	<b>\$2,877</b>	<b>\$782</b>
5"	120" x 48"	M/E1/TCO/06024/FT	<b>3,037</b>	<b>860</b>
6"	144" x 48"	M/E1/TCO/07224/FT	<b>3,197</b>	<b>909</b>

## how to order

please specify

example

1. model number M/TAO/16848
2. wood color DC
3. optional modesty panel MP
4. optional power/voice/data 03

notes:

see page 6 for wood colors

see page 8 for power/voice/data specifications

## meeting link™ for articulating tables

### specifications for preconfigured power/voice/data

table length	full table technology centers quantity	presentation end only technology centers quantity	table seating capacity length	closed capacity	open capacity	with connector table capacity
8'	3	1	8'	8	7	10
10"	3	1	10'	10	9	12
12"	3	1	12'	12	11	14
14"	3	1	14'	14	13	16

### specifications for each technology center

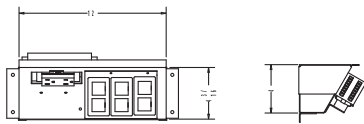

Dimensions: 12"l x 6"w

Number of outlets: two (2)

Voice/data/av connectors: capacity for up to 6 connectors

Technology center for presentation end includes: access grommet for connection to projector and permanent cord storage

Cover is brushed aluminum

### technology center connectors

Electrical jumper connects the technology centers

### table to floor connector

Single circuit power in-feed from table to floor with soft cord plug-in

### connectivity and docking station for projector built into table base

When ordered with any meeting link™ option

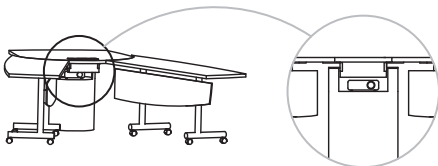

Projector mounts in base to allow immediate access. Easy table top connectivity for notebooks.

### optional: direct wire routing from wall to table without core drilling (ADA approved)



For specifying/pricing: call Nevers' customer service 1.800.242.2443 or visit [www.connectrac.com](http://www.connectrac.com)

# Simple™ conference table tops and bases

## round tables

diameter		drum base DB	metal base BS	metal base BT	power center power/ voice/data 03
size	model number	price	price	price	price
42" dia	M/TA1/04200	<b>\$2,516</b>	<b>\$2,078</b>	<b>na</b>	<b>\$539</b>
48" dia	M/TA1/04800	<b>2,987</b>	<b>2,549</b>	<b>na</b>	<b>539</b>
54" dia	M/TA1/05400	<b>3,369</b>	<b>na</b>	<b>\$3,163</b>	<b>539</b>
60" dia	M/TA1/06000	<b>3,844</b>	<b>na</b>	<b>3,639</b>	<b>539</b>
72" dia	M/TA1/07200	<b>4,339</b>	<b>na</b>	<b>na</b>	<b>539</b>



### power center for round tables with drum bases

size	model number	number of power centers	electrical outlets	voice, data and av port capacity	price
42" dia	R/PC3/01	1	2	2	<b>\$539</b>
48" dia	R/PC3/01	1	2	2	<b>539</b>
54" dia	R/PC3/01	1	2	2	<b>539</b>
60" dia	R/PC3/01	1	2	2	<b>539</b>
72" dia	R/PC3/01	1	2	2	<b>539</b>

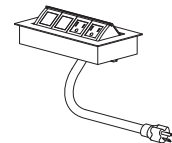

#### General Specifications:

1. Power in-feed is soft cord plug in.
2. For Meeting Link for metal bases, contact Customer Service.
3. Door frame is clear anodized aluminum.

When ordering please specify order number.

## how to order

please specify	example
1. model number & base code	M/TA1/06000/DB
2. wood color	DC
3. optional power/voice/data	03

notes:

see page 6 for wood colors

see page 8 for power/voice/data specifications

## small rectangle tables

			metal base MQ	metal base MR	power center power/ voice/data 03
30" wide					
length	size	model number	price	price	price
4'	48" x 30"	M/TB1/04830	<b>\$2,415</b>	<b>na</b>	<b>\$539</b>
5'	60" x 30"	M/TB1/06030	<b>2,724</b>	<b>na</b>	<b>539</b>
6'	72" x 30"	M/TB1/07230	<b>2,803</b>	<b>na</b>	<b>539</b>
36" wide					
6'	72" x 36"	M/TB1/07236	<b>\$3,195</b>	<b>na</b>	<b>\$539</b>
7'	84" x 36"	M/TB1/08436	<b>3,347</b>	<b>na</b>	<b>539</b>
42" wide					
6'	72" x 42"	M/TB1/07242	<b>na</b>	<b>\$3,347</b>	<b>\$539</b>
7'	84" x 42"	M/TB1/08442	<b>na</b>	<b>3,677</b>	<b>539</b>



### power center for small rectangle tables

top length	model number	number of power centers	electrical outlets	voice, data and av port capacity	price
4'	R/PC3/01	1	2	2	<b>\$539</b>
5'	R/PC3/01	1	2	2	<b>539</b>
6'	R/PC3/01	1	2	2	<b>539</b>
7'	R/PC3/01	1	2	2	<b>539</b>

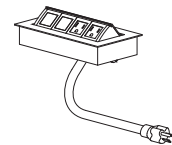

#### General Specifications:

1. Power in-feed is soft cord plug in.
2. Door frame is clear anodized aluminum.
3. 2" grommet - round R/GRM \$97

When ordering please specify order number.

## how to order

please specify	example
1. model number & base code	M/TB1/08436/MR
2. wood color	DC
3. optional power/voice/data	03

notes:

see page 6 for wood colors

see page 8 for power/voice/data specifications

**NEVERS** To place your order or get answers to product questions call 800.242.2443, fax 800.258.5591 or visit [www.nevers.com](http://www.nevers.com)

# Simple™ conference table tops and bases

## rectangle tables

			half panel bases HB	panel bases PB	rectangle bases RB	combination half panel/ bases HP	combination panel/ rectangle bases PR	meeting link optional power/ voice/data O3
<b>48" wide</b>								
length	size	model number	price	price	price	price	price	price
8'	96" x 48"	M/TC1/09648	<b>\$5,286</b>	<b>\$4,836</b>	<b>\$5,077</b>	<b>na</b>	<b>na</b>	<b>\$670</b>
10'	120" x 48"	M/TC1/12048	<b>6,021</b>	<b>5,571</b>	<b>5,849</b>	<b>na</b>	<b>na</b>	<b>670</b>
12'	144" x 48"	M/TC1/14448	<b>7,656</b>	<b>6,981</b>	<b>7,330</b>	<b>\$7,464</b>	<b>\$7,225</b>	<b>1,339</b>
14'	168" x 48"	M/TC1/16848	<b>8,466</b>	<b>7,791</b>	<b>8,180</b>	<b>8,254</b>	<b>8,063</b>	<b>1,339</b>
16'	192" x 48"	M/TC1/19248	<b>9,276</b>	<b>8,601</b>	<b>9,031</b>	<b>9,044</b>	<b>8,901</b>	<b>1,339</b>
18'	216" x 48"	M/TC1/21648	<b>10,086</b>	<b>9,411</b>	<b>9,881</b>	<b>9,833</b>	<b>9,741</b>	<b>1,339</b>
20'	240" x 48"	M/TC1/24048	<b>11,721</b>	<b>10,821</b>	<b>11,362</b>	<b>11,427</b>	<b>11,200</b>	<b>2,009</b>
22'	264" x 48"	M/TC1/26448	<b>12,531</b>	<b>11,631</b>	<b>12,213</b>	<b>12,218</b>	<b>12,038</b>	<b>2,009</b>
24'	288" x 48"	M/TC1/28848	<b>13,341</b>	<b>12,441</b>	<b>13,063</b>	<b>13,008</b>	<b>12,877</b>	<b>2,009</b>
26'	312" x 48"	M/TC1/31248	<b>14,151</b>	<b>13,251</b>	<b>13,914</b>	<b>13,797</b>	<b>13,715</b>	<b>2,678</b>
<b>54" wide</b>								
8'	96" x 54"	M/TC1/09654	<b>\$5,861</b>	<b>\$5,382</b>	<b>\$5,651</b>	<b>na</b>	<b>na</b>	<b>\$670</b>
10'	120" x 54"	M/TC1/12054	<b>6,690</b>	<b>6,209</b>	<b>6,520</b>	<b>na</b>	<b>na</b>	<b>670</b>
12'	144" x 54"	M/TC1/14454	<b>8,477</b>	<b>7,758</b>	<b>8,145</b>	<b>\$8,265</b>	<b>\$8,029</b>	<b>1,339</b>
14'	168" x 54"	M/TC1/16854	<b>9,385</b>	<b>8,666</b>	<b>9,099</b>	<b>9,151</b>	<b>8,968</b>	<b>1,339</b>
16'	192" x 54"	M/TC1/19254	<b>10,293</b>	<b>9,573</b>	<b>10,053</b>	<b>10,036</b>	<b>10,849</b>	<b>1,339</b>
18'	216" x 54"	M/TC1/21654	<b>11,202</b>	<b>10,481</b>	<b>11,005</b>	<b>10,921</b>	<b>12,450</b>	<b>1,339</b>
20'	240" x 54"	M/TC1/24054	<b>12,989</b>	<b>12,029</b>	<b>12,631</b>	<b>12,665</b>	<b>13,390</b>	<b>2,009</b>
22'	264" x 54"	M/TC1/26454	<b>13,897</b>	<b>12,937</b>	<b>13,584</b>	<b>13,550</b>	<b>14,331</b>	<b>2,009</b>
24'	288" x 54"	M/TC1/28854	<b>14,806</b>	<b>13,846</b>	<b>14,538</b>	<b>14,435</b>	<b>14,331</b>	<b>2,009</b>
26'	312" x 54"	M/TC1/31254	<b>15,714</b>	<b>14,754</b>	<b>15,492</b>	<b>15,321</b>	<b>15,270</b>	<b>2,678</b>
<b>60" wide</b>								
8'	96" x 60"	M/TC1/09660	<b>\$6,307</b>	<b>\$5,828</b>	<b>\$6,118</b>	<b>na</b>	<b>na</b>	<b>\$670</b>
10'	120" x 60"	M/TC1/12060	<b>7,179</b>	<b>6,699</b>	<b>7,034</b>	<b>na</b>	<b>na</b>	<b>670</b>
12'	144" x 60"	M/TC1/14460	<b>9,012</b>	<b>8,291</b>	<b>8,706</b>	<b>\$8,786</b>	<b>\$8,582</b>	<b>1,339</b>
14'	168" x 60"	M/TC1/16860	<b>10,916</b>	<b>9,244</b>	<b>9,706</b>	<b>9,714</b>	<b>9,567</b>	<b>1,339</b>
16'	192" x 60"	M/TC1/19260	<b>10,916</b>	<b>10,195</b>	<b>10,705</b>	<b>10,642</b>	<b>10,553</b>	<b>1,339</b>
18'	216" x 60"	M/TC1/21660	<b>11,867</b>	<b>11,148</b>	<b>11,214</b>	<b>11,571</b>	<b>11,538</b>	<b>1,339</b>
20'	240" x 60"	M/TC1/24060	<b>13,700</b>	<b>12,740</b>	<b>13,377</b>	<b>13,357</b>	<b>13,186</b>	<b>2,009</b>
22'	264" x 60"	M/TC1/26460	<b>14,651</b>	<b>13,691</b>	<b>14,376</b>	<b>14,285</b>	<b>14,171</b>	<b>2,009</b>
24'	288" x 60"	M/TC1/28860	<b>15,604</b>	<b>14,644</b>	<b>15,376</b>	<b>15,213</b>	<b>15,156</b>	<b>2,009</b>
26'	312" x 60"	M/TC1/31260	<b>16,555</b>	<b>15,595</b>	<b>16,375</b>	<b>16,142</b>	<b>16,142</b>	<b>2,678</b>

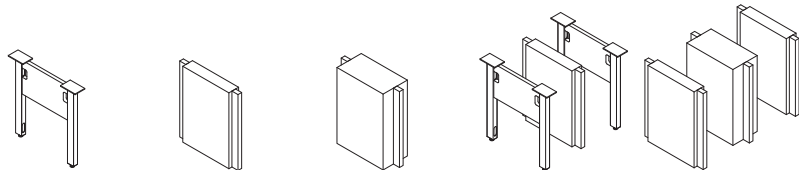

## how to order

## combination base configurations

please specify	example	table length	half panel/panel bases	panel/rectangle bases
1. model number & base code	M/TC1/16860/PR	12' - 18'	2 half panel & 1 panel	2 panel & 1 rectangle
2. wood color	DC	20' - 24'	2 half panel & 2 panel	2 panel & 2 rectangle
3. optional power/voice/data	O3/HW	26'	3 half panel & 2 panel (alternating half panel/panel)	3 panel & 2 rectangle (alternating panel/rectangle)

## arc rectangle tables

			half panel bases HB	panel bases PB	rectangle bases RB	combination half panel panel bases HP	combination panel rectangle bases PR	meeting link optional power/ voice/data 03
<b>48" wide</b>								
length	size	model number	price	price	price	price	price	price
8'	96" x 48"	M/TD1/09648	<b>\$5,550</b>	<b>\$5,077</b>	<b>\$5,331</b>	<b>na</b>	<b>na</b>	<b>\$670</b>
10'	120" x 48"	M/TD1/12048	<b>6,321</b>	<b>5,849</b>	<b>6,142</b>	<b>na</b>	<b>na</b>	<b>670</b>
12'	144" x 48"	M/TD1/14448	<b>8,038</b>	<b>7,330</b>	<b>7,696</b>	<b>\$7,838</b>	<b>\$7,586</b>	<b>1,339</b>
14'	168" x 48"	M/TD1/16848	<b>8,889</b>	<b>8,180</b>	<b>8,589</b>	<b>8,667</b>	<b>8,467</b>	<b>1,339</b>
16'	192" x 48"	M/TD1/19248	<b>9,739</b>	<b>9,031</b>	<b>9,482</b>	<b>9,496</b>	<b>9,347</b>	<b>1,339</b>
18'	216" x 48"	M/TD1/21648	<b>10,590</b>	<b>9,881</b>	<b>10,376</b>	<b>10,326</b>	<b>10,228</b>	<b>1,339</b>
20'	240" x 48"	M/TD1/24048	<b>12,307</b>	<b>11,362</b>	<b>11,930</b>	<b>11,999</b>	<b>11,760</b>	<b>2,009</b>
22'	264" x 48"	M/TD1/26448	<b>13,158</b>	<b>12,213</b>	<b>12,823</b>	<b>12,828</b>	<b>12,640</b>	<b>2,009</b>
24'	288" x 48"	M/TD1/28848	<b>14,008</b>	<b>13,063</b>	<b>13,716</b>	<b>13,658</b>	<b>13,521</b>	<b>2,009</b>
26'	312" x 48"	M/TD1/31248	<b>14,859</b>	<b>13,914</b>	<b>14,609</b>	<b>14,487</b>	<b>14,401</b>	<b>2,678</b>
<b>54" wide</b>								
8'	96" x 54"	M/TD1/09654	<b>\$6,154</b>	<b>\$5,651</b>	<b>\$5,932</b>	<b>na</b>	<b>na</b>	<b>\$670</b>
10'	120" x 54"	M/TD1/12054	<b>7,024</b>	<b>6,620</b>	<b>6,846</b>	<b>na</b>	<b>na</b>	<b>670</b>
12'	144" x 54"	M/TD1/14454	<b>8,901</b>	<b>8,145</b>	<b>8,553</b>	<b>\$8,679</b>	<b>\$8,430</b>	<b>1,339</b>
14'	168" x 54"	M/TD1/16854	<b>9,855</b>	<b>9,099</b>	<b>9,554</b>	<b>9,609</b>	<b>9,418</b>	<b>1,339</b>
16'	192" x 54"	M/TD1/19254	<b>10,809</b>	<b>10,053</b>	<b>10,555</b>	<b>10,538</b>	<b>10,404</b>	<b>1,339</b>
18'	216" x 54"	M/TD1/21654	<b>11,761</b>	<b>11,005</b>	<b>11,556</b>	<b>11,467</b>	<b>11,391</b>	<b>1,339</b>
20'	240" x 54"	M/TD1/24054	<b>13,639</b>	<b>12,631</b>	<b>13,262</b>	<b>13,298</b>	<b>13,073</b>	<b>2,009</b>
22'	264" x 54"	M/TD1/26454	<b>14,593</b>	<b>13,584</b>	<b>14,264</b>	<b>14,228</b>	<b>14,059</b>	<b>2,009</b>
24'	288" x 54"	M/TD1/28854	<b>15,546</b>	<b>14,538</b>	<b>15,265</b>	<b>15,157</b>	<b>15,047</b>	<b>2,009</b>
26'	312" x 54"	M/TD1/31254	<b>16,499</b>	<b>15,492</b>	<b>16,266</b>	<b>16,087</b>	<b>16,034</b>	<b>2,678</b>
<b>60" wide</b>								
8'	96" x 60"	M/TD1/09660	<b>\$6,623</b>	<b>\$6,118</b>	<b>\$6,425</b>	<b>na</b>	<b>na</b>	<b>\$670</b>
10'	120" x 60"	M/TD1/12060	<b>7,538</b>	<b>7,034</b>	<b>7,386</b>	<b>na</b>	<b>na</b>	<b>670</b>
12'	144" x 60"	M/TD1/14460	<b>9,462</b>	<b>8,706</b>	<b>9,141</b>	<b>\$9,225</b>	<b>\$9,010</b>	<b>1,339</b>
14'	168" x 60"	M/TD1/16860	<b>10,462</b>	<b>9,706</b>	<b>10,191</b>	<b>10,200</b>	<b>10,045</b>	<b>1,339</b>
16'	192" x 60"	M/TD1/19260	<b>11,461</b>	<b>10,705</b>	<b>11,241</b>	<b>11,175</b>	<b>11,080</b>	<b>1,339</b>
18'	216" x 60"	M/TD1/21660	<b>12,461</b>	<b>11,705</b>	<b>12,290</b>	<b>12,149</b>	<b>12,114</b>	<b>1,339</b>
20'	240" x 60"	M/TD1/24060	<b>14,385</b>	<b>13,377</b>	<b>14,045</b>	<b>14,025</b>	<b>13,845</b>	<b>2,009</b>
22'	264" x 60"	M/TD1/26460	<b>15,384</b>	<b>14,376</b>	<b>15,095</b>	<b>14,999</b>	<b>14,879</b>	<b>2,009</b>
24'	288" x 60"	M/TD1/28860	<b>16,384</b>	<b>15,376</b>	<b>16,145</b>	<b>15,974</b>	<b>15,914</b>	<b>2,009</b>
26'	312" x 60"	M/TD1/31260	<b>17,384</b>	<b>16,375</b>	<b>17,194</b>	<b>16,948</b>	<b>16,948</b>	<b>2,678</b>

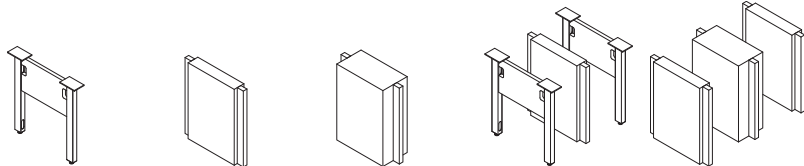

## how to order

## combination base configurations

please specify	example	table length	half panel/panel bases	panel/rectangle bases
1. model number & base code	M/TD1/16860/PR	12' - 18'	2 half panel & 1 panel	2 panel & 1 rectangle
2. wood color	DC	20' - 24'	2 half panel & 2 panel	2 panel & 2 rectangle
3. optional power/voice/data	03	26'	3 half panel & 2 panel (alternating half panel/panel)	3 panel & 2 rectangle (alternating panel/rectangle)
notes: see page 6 for wood colors see page 8 for power/voice/data specifications				

# Simple™ conference table tops and bases

## boat tables

48" w x 39" w ends			half panel bases HB	panel bases PB	rectangle bases RB	combination half panel panel bases HP	combination panel rectangle bases PR	meeting link optional power/voice/data O3
length	size	model number	price	price	price	price	price	price
8'	96" x 48"	M/TE1/09648	\$5,550	\$5,077	\$5,331	na	na	\$670
10'	120" x 48"	M/TE1/12048	6,321	5,849	6,142	na	na	670
12'	144" x 48"	M/TE1/14448	8,038	7,330	7,696	\$7,838	\$7,586	1,339
14'	168" x 48"	M/TE1/16848	8,889	8,180	8,589	8,667	8,467	1,339
16'	192" x 48"	M/TE1/19248	9,739	9,031	9,482	9,496	9,347	1,339
18'	216" x 48"	M/TE1/21648	10,590	9,881	10,376	10,326	10,228	1,339
20'	240" x 48"	M/TE1/24048	12,307	11,362	11,930	11,999	11,760	2,009
22'	264" x 48"	M/TE1/26448	13,158	12,213	12,823	12,828	12,640	2,009
24'	288" x 48"	M/TE1/28848	14,008	13,063	13,716	13,658	13,521	2,009
26'	312" x 48"	M/TE1/31248	14,859	13,914	14,609	14,487	14,401	2,678
<b>54" w x 42" w ends</b>								
8'	96" x 54"	M/TE1/09654	\$6,154	\$5,651	\$5,932	na	na	\$670
10'	120" x 54"	M/TE1/12054	7,024	6,620	6,846	na	na	670
12'	144" x 54"	M/TE1/14454	8,901	8,145	8,553	\$8,679	\$8,430	1,339
14'	168" x 54"	M/TE1/16854	9,855	9,099	9,554	9,609	9,418	1,339
16'	192" x 54"	M/TE1/19254	10,809	10,053	10,555	10,538	10,404	1,339
18'	216" x 54"	M/TE1/21654	11,761	11,005	11,556	11,467	11,391	1,339
20'	240" x 54"	M/TE1/24054	13,639	12,631	13,262	13,298	13,073	2,009
22'	264" x 54"	M/TE1/26454	14,593	13,584	14,264	14,228	14,059	2,009
24'	288" x 54"	M/TE1/28854	15,546	14,538	15,265	15,157	15,047	2,009
26'	312" x 54"	M/TE1/31254	16,499	15,492	16,266	16,087	16,034	2,678
<b>60" w x 44" w ends</b>								
8'	96" x 60"	M/TE1/09660	\$6,623	\$6,118	\$6,425	na	na	\$670
10'	120" x 60"	M/TE1/12060	7,538	7,034	7,386	na	na	670
12'	144" x 60"	M/TE1/14460	9,462	8,706	9,141	\$9,225	\$9,010	1,339
14'	168" x 60"	M/TE1/16860	10,462	9,706	10,191	10,200	10,045	1,339
16'	192" x 60"	M/TE1/19260	11,461	10,705	11,241	11,175	11,080	1,339
18'	216" x 60"	M/TE1/21660	12,461	11,705	12,290	12,149	12,114	1,339
20'	240" x 60"	M/TE1/24060	14,385	13,377	14,045	14,025	13,845	2,009
22'	264" x 60"	M/TE1/26460	15,384	14,376	15,095	14,999	14,879	2,009
24'	288" x 60"	M/TE1/28860	16,384	15,376	16,145	15,974	15,914	2,009
26'	312" x 60"	M/TE1/31260	17,384	16,375	17,194	16,948	16,948	2,678

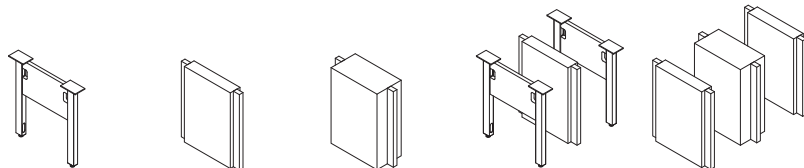

## how to order

## combination base configurations

please specify	example	table length	half panel/panel bases	panel/rectangle bases
1. model number & base code	M/TE1/16860/PR	12' - 18'	2 half panel & 1 panel	2 panel & 1 rectangle
2. wood color	DC	20' - 24'	2 half panel & 2 panel	2 panel & 2 rectangle
3. optional power/voice/data	O3	26'	3 half panel & 2 panel	3 panel & 2 rectangle
notes:			(alternating half panel/panel)	(alternating panel/rectangle)

see page 6 for wood colors

see page 8 for power/voice/data specifications

## arc boat tables

			half panel bases HB	panel bases PB	rectangle bases RB	combination half panel panel bases HP	combination panel rectangle bases PR	meeting link optional power/ voice/data 03
<b>48" w x 39" w ends</b>								
length	size	model number	price	price	price	price	price	price
8'	96" x 48"	M/TF1/09648	<b>\$5,828</b>	<b>\$5,331</b>	<b>\$5,598</b>	<b>na</b>	<b>na</b>	<b>\$670</b>
10'	120" x 48"	M/TF1/12048	<b>6,638</b>	<b>6,142</b>	<b>6,449</b>	<b>na</b>	<b>na</b>	<b>670</b>
12'	144" x 48"	M/TF1/14448	<b>8,440</b>	<b>7,696</b>	<b>8,082</b>	<b>\$8,230</b>	<b>\$7,966</b>	<b>1,339</b>
14'	168" x 48"	M/TF1/16848	<b>9,333</b>	<b>8,589</b>	<b>9,019</b>	<b>9,100</b>	<b>8,889</b>	<b>1,339</b>
16'	192" x 48"	M/TF1/19248	<b>10,227</b>	<b>9,482</b>	<b>9,957</b>	<b>9,971</b>	<b>9,814</b>	<b>1,339</b>
18'	216" x 48"	M/TF1/21648	<b>11,120</b>	<b>10,376</b>	<b>10,894</b>	<b>10,842</b>	<b>10,738</b>	<b>1,339</b>
20'	240" x 48"	M/TF1/24048	<b>12,922</b>	<b>11,930</b>	<b>12,527</b>	<b>12,599</b>	<b>12,348</b>	<b>2,009</b>
22'	264" x 48"	M/TF1/26448	<b>13,816</b>	<b>12,823</b>	<b>13,464</b>	<b>13,470</b>	<b>13,272</b>	<b>2,009</b>
24'	288" x 48"	M/TF1/28848	<b>14,709</b>	<b>13,716</b>	<b>14,402</b>	<b>14,340</b>	<b>14,197</b>	<b>2,009</b>
26'	312" x 48"	M/TF1/31248	<b>15,602</b>	<b>14,609</b>	<b>15,339</b>	<b>15,212</b>	<b>15,121</b>	<b>2,678</b>
<b>54" w x 42" w ends</b>								
8'	96" x 54"	M/TF1/09654	<b>\$6,462</b>	<b>\$5,932</b>	<b>\$6,229</b>	<b>na</b>	<b>na</b>	<b>\$670</b>
10'	120" x 54"	M/TF1/12054	<b>7,375</b>	<b>6,846</b>	<b>7,188</b>	<b>na</b>	<b>na</b>	<b>670</b>
12'	144" x 54"	M/TF1/14454	<b>9,346</b>	<b>8,553</b>	<b>10,031</b>	<b>\$9,113</b>	<b>\$8,852</b>	<b>1,339</b>
14'	168" x 54"	M/TF1/16854	<b>10,347</b>	<b>9,554</b>	<b>11,083</b>	<b>10,088</b>	<b>9,888</b>	<b>1,339</b>
16'	192" x 54"	M/TF1/19254	<b>11,349</b>	<b>10,555</b>	<b>12,134</b>	<b>11,065</b>	<b>10,924</b>	<b>1,339</b>
18'	216" x 54"	M/TF1/21654	<b>12,350</b>	<b>11,556</b>	<b>13,926</b>	<b>12,041</b>	<b>11,960</b>	<b>1,339</b>
20'	240" x 54"	M/TF1/24054	<b>14,321</b>	<b>13,262</b>	<b>13,926</b>	<b>13,963</b>	<b>13,727</b>	<b>2,009</b>
22'	264" x 54"	M/TF1/26454	<b>15,314</b>	<b>14,264</b>	<b>14,976</b>	<b>14,939</b>	<b>14,763</b>	<b>2,009</b>
24'	288" x 54"	M/TF1/28854	<b>16,323</b>	<b>15,265</b>	<b>16,028</b>	<b>15,915</b>	<b>15,799</b>	<b>2,009</b>
26'	312" x 54"	M/TF1/31254	<b>17,324</b>	<b>16,266</b>	<b>17,079</b>	<b>16,891</b>	<b>16,835</b>	<b>2,678</b>
<b>60" w x 44" w ends</b>								
8'	96" x 60"	M/TF1/09660	<b>\$6,954</b>	<b>\$6,425</b>	<b>\$6,746</b>	<b>na</b>	<b>na</b>	<b>\$670</b>
10'	120" x 60"	M/TF1/12060	<b>7,915</b>	<b>7,386</b>	<b>7,755</b>	<b>na</b>	<b>na</b>	<b>670</b>
12'	144" x 60"	M/TF1/14460	<b>9,935</b>	<b>9,141</b>	<b>9,598</b>	<b>\$9,687</b>	<b>\$9,461</b>	<b>1,339</b>
14'	168" x 60"	M/TF1/16860	<b>10,985</b>	<b>10,191</b>	<b>10,701</b>	<b>10,710</b>	<b>10,547</b>	<b>1,339</b>
16'	192" x 60"	M/TF1/19260	<b>12,034</b>	<b>11,241</b>	<b>11,802</b>	<b>11,733</b>	<b>11,634</b>	<b>1,339</b>
18'	216" x 60"	M/TF1/21660	<b>13,084</b>	<b>12,290</b>	<b>12,905</b>	<b>12,757</b>	<b>12,720</b>	<b>1,339</b>
20'	240" x 60"	M/TF1/24060	<b>15,104</b>	<b>14,045</b>	<b>14,747</b>	<b>14,726</b>	<b>14,537</b>	<b>2,009</b>
22'	264" x 60"	M/TF1/26460	<b>16,154</b>	<b>15,095</b>	<b>15,850</b>	<b>15,750</b>	<b>15,623</b>	<b>2,009</b>
24'	288" x 60"	M/TF1/28860	<b>17,199</b>	<b>16,145</b>	<b>16,952</b>	<b>16,772</b>	<b>16,710</b>	<b>2,009</b>
26'	312" x 60"	M/TF1/31260	<b>18,252</b>	<b>17,194</b>	<b>18,053</b>	<b>17,796</b>	<b>17,796</b>	<b>2,678</b>

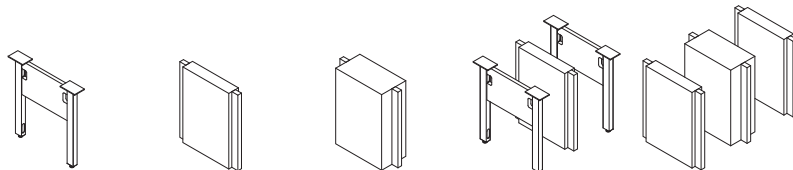

## how to order

## combination base configurations

please specify	example	table length	half panel/panel bases	panel/rectangle bases
1. model number & base code	M/TF1/16860/PR	12' - 18'	2 half panel & 1 panel	2 panel & 1 rectangle
2. wood color	DC	20' - 24'	2 half panel & 2 panel	2 panel & 2 rectangle
3. optional power/voice/data	03	26'	3 half panel & 2 panel (alternating half panel/panel)	3 panel & 2 rectangle (alternating panel/rectangle)
notes: see page 6 for wood colors see page 8 for power/voice/data specifications				

# Simple™ conference table tops and bases

## racetrack tables

48" wide			half drum bases HD	drum bases DB	combination half drum/ rectangle bases DR	optional power/ voice/data O3
length	size	mmodel number	price	price	price	price
8'	96" x 48"	M/TG1/09648	<b>\$5,229</b>	<b>\$5,390</b>	<b>na</b>	<b>\$670</b>
10'	120" x 48"	M/TG1/12048	<b>5,942</b>	<b>6,126</b>	<b>na</b>	<b>670</b>
12'	144" x 48"	M/TG1/14448	<b>na</b>	<b>7,814</b>	<b>\$8,364</b>	<b>1,339</b>
14'	168" x 48"	M/TG1/16848	<b>na</b>	<b>8,624</b>	<b>9,334</b>	<b>1,339</b>
16'	192" x 48"	M/TG1/19248	<b>na</b>	<b>9,434</b>	<b>10,305</b>	<b>1,339</b>
18'	216" x 48"	M/TG1/21648	<b>na</b>	<b>10,244</b>	<b>11,275</b>	<b>1,339</b>
20'	240" x 48"	M/TG1/24048	<b>na</b>	<b>11,931</b>	<b>12,965</b>	<b>2,009</b>
22'	264" x 48"	M/TG1/26448	<b>na</b>	<b>12,741</b>	<b>13,935</b>	<b>2,009</b>
24'	288" x 48"	M/TG1/28848	<b>na</b>	<b>13,551</b>	<b>14,906</b>	<b>2,009</b>
26'	312" x 48"	M/TG1/31248	<b>na</b>	<b>14,361</b>	<b>15,877</b>	<b>2,678</b>

### 54" wide

8'	96" x 54"	M/TG1/09654	<b>\$5,794</b>	<b>\$5,973</b>	<b>na</b>	<b>\$670</b>
10'	120" x 54"	M/TG1/12054	<b>6,598</b>	<b>6,802</b>	<b>na</b>	<b>670</b>
12'	144" x 54"	M/TG1/14454	<b>na</b>	<b>8,645</b>	<b>\$9,294</b>	<b>1,339</b>
14'	168" x 54"	M/TG1/16854	<b>na</b>	<b>9,554</b>	<b>10,382</b>	<b>1,339</b>
16'	192" x 54"	M/TG1/19254	<b>na</b>	<b>10,462</b>	<b>11,471</b>	<b>1,339</b>
18'	216" x 54"	M/TG1/21654	<b>na</b>	<b>11,369</b>	<b>12,558</b>	<b>1,339</b>
20'	240" x 54"	M/TG1/24054	<b>na</b>	<b>13,214</b>	<b>14,413</b>	<b>2,009</b>
22'	264" x 54"	M/TG1/26454	<b>na</b>	<b>14,122</b>	<b>15,501</b>	<b>2,009</b>
24'	288" x 54"	M/TG1/28854	<b>na</b>	<b>15,029</b>	<b>16,589</b>	<b>2,009</b>
26'	312" x 54"	M/TG1/31254	<b>na</b>	<b>15,938</b>	<b>17,677</b>	<b>2,678</b>

### 60" wide

8'	96" x 60"	M/TG1/09660	<b>\$6,226</b>	<b>\$6,420</b>	<b>na</b>	<b>\$670</b>
10'	120" x 60"	M/TG1/12060	<b>7,973</b>	<b>7,291</b>	<b>na</b>	<b>670</b>
12'	144" x 60"	M/TG1/14460	<b>na</b>	<b>9,179</b>	<b>\$9,934</b>	<b>1,339</b>
14'	168" x 60"	M/TG1/16860	<b>na</b>	<b>10,131</b>	<b>11,074</b>	<b>1,339</b>
16'	192" x 60"	M/TG1/19260	<b>na</b>	<b>11,083</b>	<b>12,216</b>	<b>1,339</b>
18'	216" x 60"	M/TG1/21660	<b>na</b>	<b>12,036</b>	<b>13,356</b>	<b>1,339</b>
20'	240" x 60"	M/TG1/24060	<b>na</b>	<b>13,923</b>	<b>15,264</b>	<b>2,009</b>
22'	264" x 60"	M/TG1/26460	<b>na</b>	<b>14,876</b>	<b>16,404</b>	<b>2,009</b>
24'	288" x 60"	M/TG1/28860	<b>na</b>	<b>15,827</b>	<b>17,545</b>	<b>2,009</b>
26'	312" x 60"	M/TG1/31260	<b>na</b>	<b>16,780</b>	<b>18,686</b>	<b>2,678</b>

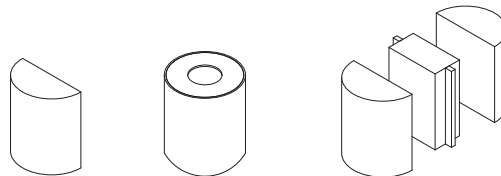

## how to order

please specify	example
1. model number & base code	M/TG1/16860/PR
2. wood color	DC
3. optional power/voice/data	O3
notes:	
see page 6 for wood colors	
see page 8 for power/voice/data specifications	

## combination base configurations

table length	half drum/rectangle bases
12' - 18'	2 half drum & 1 rectangle
20' - 24'	2 half drum & 1 rectangle
26'	2 half drum & 1 rectangle

## viewpoint tables

ends are 30" w and 60" w			half panel bases HB	panel bases PB	rectangle bases RB	combination half panel/ panel bases HP	combination panel/ rectangle bases PR	optional power/ voice/data O3
length	size	model number	price	price	price	price	price	price
8'	96" x 60"	M/TH1/09660	<b>\$6,305</b>	<b>\$5,817</b>	<b>\$6,182</b>	<b>na</b>	<b>na</b>	<b>\$670</b>
10'	120" x 60"	M/TH1/12060	<b>7,335</b>	<b>6,827</b>	<b>7,191</b>	<b>na</b>	<b>na</b>	<b>670</b>
12'	144" x 60"	M/TH1/14460	<b>9,623</b>	<b>8,897</b>	<b>9,434</b>	<b>\$9,422</b>	<b>\$9,237</b>	<b>1,339</b>
14'	168" x 60"	M/TH1/16860	<b>10,927</b>	<b>10,177</b>	<b>10,714</b>	<b>10,728</b>	<b>10,517</b>	<b>1,339</b>
16'	192" x 60"	M/TH1/19260	<b>11,944</b>	<b>11,173</b>	<b>11,709</b>	<b>11,743</b>	<b>11,513</b>	<b>1,339</b>
18'	216" x 60"	M/TH1/21660	<b>13,273</b>	<b>12,476</b>	<b>13,013</b>	<b>13,073</b>	<b>12,816</b>	<b>1,339</b>
20'	240" x 60"	M/TH1/24060	<b>15,121</b>	<b>14,109</b>	<b>14,824</b>	<b>15,061</b>	<b>14,766</b>	<b>2,009</b>

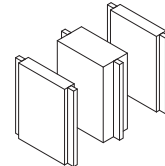
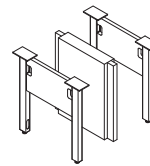
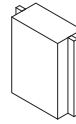
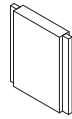
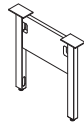

## how to order

please specify                      example

1. model number & base code    M/TH1/16860/PR  
 2. wood color                        DC  
 3. optional power/voice/data    O3

notes:  
 see page 6 for wood colors  
 see page 8 for power/voice/data specifications

## combination base configurations

table length	half panel/panel bases	panel/rectangle bases
12' - 18'	2 half panel & 1 panel	2 panel & 1 rectangle
20'	2 half panel & 2 panel	2 panel & 2 rectangle

## storage credenzas/e-credenzas units require finishing top—ends are color coat silver

single wide cabinet  
with one door and one shelf

16w 16d 30h M/CSA/01616 **\$1,353**  
16w 22d 30h M/CSB/01622 **\$1,560**  
door hinged right -R

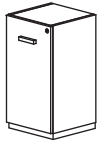

double wide cabinet  
with two doors and one shelf

32w 16d 30h M/CSA/03216 **\$2,090**  
32w 22d 30h M/CSB/03222 **\$2,411**  
equipment rack ready with  
vented bottom/back -E

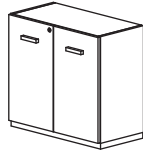

double wide e-cabinet equipment  
rack ready with one door one vented  
door and vented back

32w 22d 30h M/CSC/03222 **\$2,174**  
vented door right -R

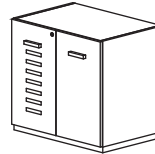

cabinet with box/recycle drawer  
and single door and shelf

32w 16d 30h M/CSD/03216 **\$2,938**  
32w 22d 30h M/CSE/03222 **\$3,251**  
drawers right -R

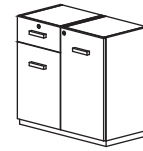

## storage/display cabinets units require finishing top—ends are color coat silver

double wide cabinet  
with two wood doors and  
three shelves

32w 16d 66h M/MDP/03216 **\$3,034**  
32w 22d 66h M/MDP/03222 **\$3,547**

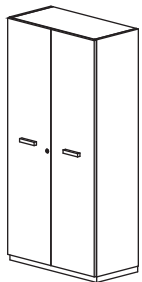

double wide cabinet  
with open bookcase and  
three shelves

32w 16d 66h M/MDQ/03216 **\$1,800**  
32w 22d 66h M/MDQ/03222 **\$2,313**

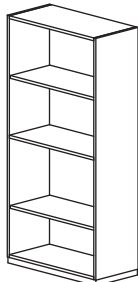

double wide cabinet  
with two glass doors and  
three clear glass shelves

32w 16d 66h M/MDW/03216 **\$3,524**  
32w 22d 66h M/MDW/03222 **\$4,161**

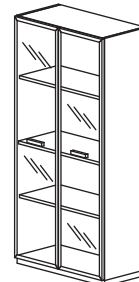

single wide cabinet  
with wood door and  
four shelves

16w 16d 78h M/MDD/01616 **\$2,185**  
16w 22d 78h M/MDD/01622 **\$2,595**  
door hinged right -R



## finishing tops

wood

16w 16d .75h M/WFT/01616 **\$269**  
32w 16d .75h M/WFT/03216 **\$355**  
48w 16d .75h M/WFT/04816 **\$435**  
64w 16d .75h M/WFT/06416 **\$519**  
  
16w 22d .75h M/WFT/01622 **\$300**  
32w 22d .75h M/WFT/03222 **\$408**  
48w 22d .75h M/WFT/04822 **\$515**  
64w 22d .75h M/WFT/06422 **\$622**  
80w 22d .75h M/WFT/08022 **\$730**  
96w 22d .75h M/WFT/09622 **\$837**



etched glass 3/8" h  
with 3/8" h colorcoat plinth

16w 16d .75h M/EGT/01616 **\$455**  
32w 16d .75h M/EGT/03216 **\$801**  
48w 16d .75h M/EGT/04816 **\$1,147**  
64w 16d .75h M/EGT/06416 **\$1,428**  
  
16w 22d .75h M/EGT/01622 **\$476**  
32w 22d .75h M/EGT/03222 **\$951**  
48w 22d .75h M/EGT/04822 **\$1,428**  
64w 22d .75h M/EGT/06422 **\$1,903**



## buffet shelf option for credenzas

etched glass shelf 1/2" h  
with 3" 1/2" h colorcoat plinth  
requires wood finishing top

16w 8d 4h M/BST/01608 **\$441**  
32w 8d 4h M/BST/03208 **\$681**  
48w 8d 4h M/BST/04808 **\$923**  
64w 8d 4h M/BST/06408 **\$1,164**



**buffet credenzas** units require finishing top—ends are color coat silver

double wide cabinet  
with open bookcase and one shelf

32w 16d 30h M/BKG/03216 **\$1,284**  
32w 22d 30h M/BKC/03222 **\$1,596**

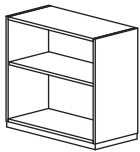

double wide buffet cabinet with  
pull out service shelf, two doors and  
one shelf

32w 16d 35h M/CBA/03216 **\$2,711**  
32w 22d 35h M/CBB/03222 **\$3,046**



buffet cabinet with pull out service shelf,  
utensil/box/recycle drawers, door and shelf

32w 16d 35h M/CBC/03216 **\$3,493**  
32w 22d 35h M/CBD/03222 **\$3,904**  
drawers right -R



single wide cabinet  
with etched glass door and  
four clear glass shelves

16w 16d 78h M/MDB/01616 **\$2,478**  
16w 22d 78h M/MDB/01622 **\$2,857**

door hinged right -R

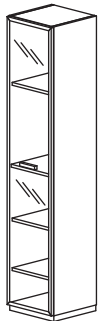

double wide cabinet  
with two wood doors and  
four shelves

32w 16d 78h M/MDI/03216 **\$3,392**  
32w 22d 78h M/MDI/03222 **\$3,985**

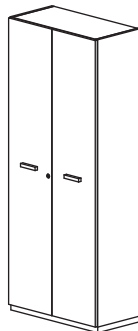

double wide cabinet  
with open bookcase and  
four shelves

32w 16d 78h M/MDF/03216 **\$2,016**  
32w 22d 78h M/MDF/03222 **\$2,608**

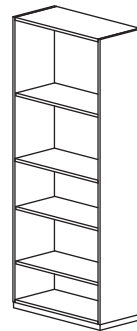

double wide cabinet  
with etched glass doors and  
four clear glass shelves

32w 16d 78h M/MDG/03216 **\$4,164**  
32w 22d 78h M/MDG/03222 **\$4,917**

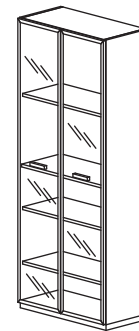

**how to order**

**wood veneers and colors**

please specify      example

1. cabinet(s) from left to right
  - a. cabinet      M/CSD/01616
  - b. cabinet      M/CSA/01616
2. finishing top      M/WFT/01616
3. wood color              DC

see page 6 for colors and model numbers

**low credenzas** ends are color coat silver

single wide cabinet ends  
open shelving middle

cabinet divider behind doors in middle  
2 wood sliding doors

64w 16d 27h M/CNA/06416 **\$3,845**  
64w 22d 27h M/CNA/06422 **\$4,271**

72w 16d 27h M/CNG/07216 **\$4,005**  
72w 22d 27h M/CNG/07222 **\$4,428**

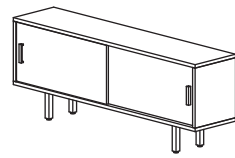
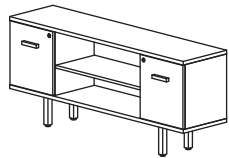

**wall mount buffet**

wall mount wood serving cabinet

64w 10d 9h M/WMB/06409 **\$996**



**wall mount for flat screen monitor**

vertical grain wood mounting face  
3/4"d with 2"d cabinet behind for wire  
management

48w 8d 30h M/MPM/04808 **\$1,072**  
64w 8d 42h M/MPM/06408 **\$1,479**

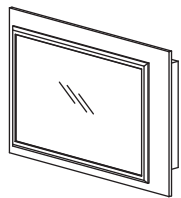

**porcelain boards**

porcelain enamel writing surface  
with colorcoat top and bottom trim  
and wood sides

72w 2.5d 48h M/SYS/07248 **\$1,759**  
96w 2.5d 48h M/SYS/09648 **\$2,197**

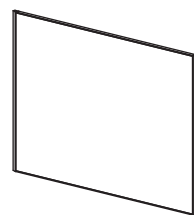

**hospitality cart** ends are color coat silver **lectern** ends are color coat silver

double wide cabinet with pull out serving shelf, bumper guard on bottom and four casters

2 legs front, 2 casters back, raised etched glass water glass shelf, adjustable reading shelf, bumper guard on bottom

32w 22d 36h M/HOC/03236 **\$3,061**

32w 22d 48h M/LEC/04832 **\$3,154**

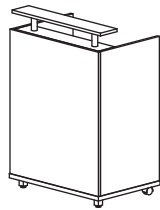

**visual boards**

wood doors with silver colorcoat trim top and porcelain enamel writing surface with pull down projection screen wood doors

with silver colorcoat trim top and bottom porcelain enamel writing surface with pull down projection screen

48w 3.5d 49h M/VIS/04849 **\$1,706**

72w 3.5d 49h M/VIS/07249 **\$2,074**

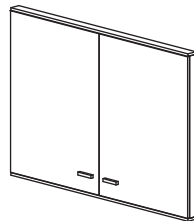
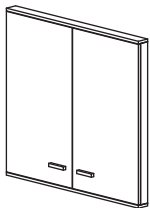

**how to order**

**wood veneers and colors**

please specify      example

- 1. model      M/VIS/07249
- 2. wood color      DC

see page 6 for colors and model numbers

# Simple™ preconfigured

## storage credenzas ends are color coat silver

single wide cabinet left  
double side cabinet right

48w 16d 30h M/CSA/04816 **\$3,256**  
48w 22d 30h M/CSB/04822 **\$3,777**

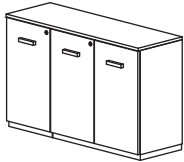

single wide cabinet left and right  
box drawer/recycle bin cabinet middle

48w 16d 30h M/CSD/04816 **\$4,104**  
48w 22d 30h M/CSE/04822 **\$4,617**

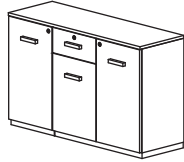

single wide cabinet left, double wide  
cabinet right with vented door and back  
for rack equipment

48w 22d 30h M/CSC/04822 **\$3,540**

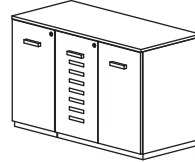

## buffet credenzas ends are color coat silver

2 double wide cabinets with  
4h etched glass buffet shelf

64w 16d 34h M/CGA/06416 **\$5,158**  
64w 22d 34h M/CGB/06422 **\$5,792**

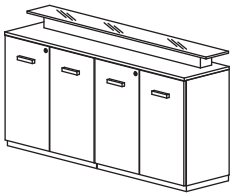

2 double wide cabinets with  
2 pull out serving shelves

64w 16d 35h M/CBA/06416 **\$5,236**  
64w 22d 35h M/CBB/06422 **\$5,899**

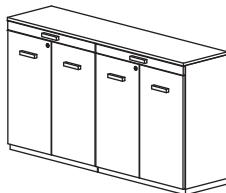

utensil drawer/box drawer/recycle bin cabinet  
single wide cabinet double wide cabinet and  
1 pull out serving shelves

64w 16d 35h M/CBC/06416 **\$6,018**  
64w 22d 35h M/CBD/06422 **\$6,758**

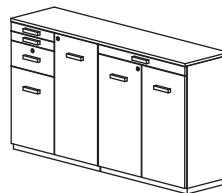

## mediawall ends are color coat silver

mount for plasma monitor, 2 single wide  
cabinets with wood doors, 2 double wide  
cabinets with etched glass shelf

96w 16d 78h M/MDR/09616 **\$10,600**

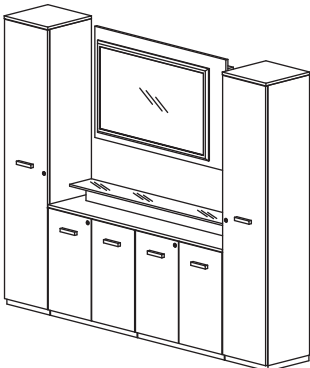

mount for plasma monitor, 2 single wide  
cabinets with etched glass doors and clear glass shelves  
low credenza with 2 sliding wood doors

104w 22d 78h M/MDR/10422 **\$11,400**

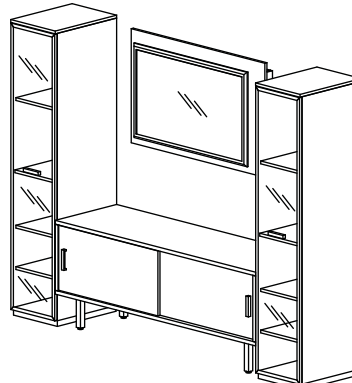

2 double wide cabinets, 22d version  
may be specified as e-credenza vented  
back and bottom for rack mount

64w 16d 30h M/CSA/06416 **\$3,994**  
64w 22d 30h M/CSB/06422 **\$4,628**  
e-credenza -e

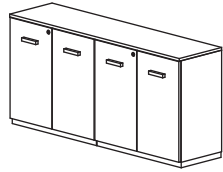

2 double wide cabinets  
with etched glass top

64w 16d 30h M/CGC/06416 **\$4,967**  
64w 22d 30h M/CGD/06422 **\$5,909**

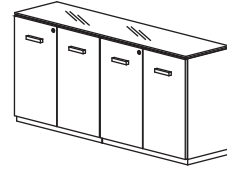

box drawer/recycle bin cabinet  
single wide cabinet  
double wide cabinet

64w 16d 30h M/CSD/06416 **\$4,841**  
64w 22d 30h M/CSE/06422 **\$5,468**

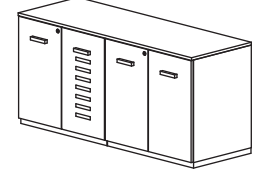
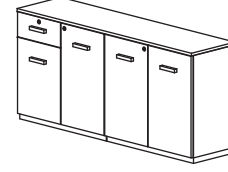

**storage/display cabinets** ends are color coat silver

double wide cabinet with wood doors  
double wide display cabinet

64w 16d 66h M/MDX/06416 **\$4,648**  
64w 22d 66h M/MDX/06422 **\$5,668**

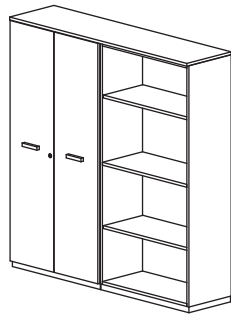

double wide cabinet with wood doors  
double wide cabinet with etched  
glass doors

64w 16d 66h M/MDZ/06416 **\$6,922**  
64w 22d 66h M/MDZ/06422 **\$7,941**

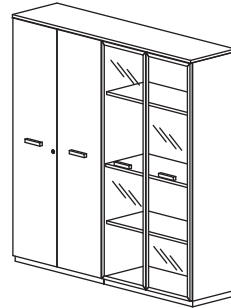

**how to order**

- please specify      example
1. product      M/MDZ/06416
  2. wood color      DC

**wood veneers and colors**

see page 6 for colors and model numbers





NEVERS

The Complete Meeting Room™

14125 21st Avenue North, Minneapolis, Minnesota 55447

P: 763.553.1632 | 800.242.2443 | F: 763.553.1770 | 800.258.5591

[www.nevers.com](http://www.nevers.com)